



MM8
TACTICAL EQUIPMENT



YOUR SAFETY IS OUR PRIORITY



ANACONDA

THERMAL IMAGING CLIP-ON



The AGM Anaconda is a compact thermal imaging clip-on system that allows quick transformation of the day optics into thermal imaging device without any special skills. The Anaconda can be easily attached on up to 8x magnification scopes for medium range use.

Powered with two CR123 batteries the unit provides up to 5 hours of continuous work. An optional external battery pack (5V) with high-capacity is capable of increasing the total operation time to up to 44 hours.

The Anaconda can be also connected to an optional video recorder for shooting real time video or external Wi-Fi module for conjunction with smartphones.

- Quick conversion of daytime optics into thermal imaging scope
- Mounts in front of any daytime scope, no re-zeroing is required
- FLIR Tau 2 17 μ m pitch thermal sensor
- Lightweight and robust design
- Easy to operate device
- Manually adjustable objective lens
- Real-time display
- Multiple color palettes
- Wireless remote control
- Waterproof
- External Wi-Fi module via micro USB
- Integral MIL-STD-1913 rails for optional accessories
- Powered by two standard CR123A batteries
- External power supply via micro USB
- Limited 3-Year Warranty



Equipment described herein is subject to US export regulations and may require a license prior to export. Diversion contrary to US law is prohibited.

SPECIFICATIONS

	Anaconda TC50-336	Anaconda TC50-640
Detector	FLIR Tau 2 336x256 17µm Uncooled Microbolometer	FLIR Tau 2 640x512 17µm Uncooled Microbolometer
Video Refresh Rate	60 Hz	60 Hz
Start Up	3 seconds	3 seconds
Lens System	50 mm; F/1.0	50 mm; F/1.0
Optical Magnification	1x	1x
Field of View (H × V)	7.8° × 5.9°	14.8° × 11.8°
Digital Zoom	1x, 2x, 4x	1x, 2x, 4x, 8x
Exit Pupil Diameter	40 mm	25 mm
Focusing Range	5 m to infinity	5 m to infinity
Display Resolution	800x600 pixels	
Video Output	PAL (768x574 pixels) / NTSC (640x480 pixels)	
Temperature Imaging Palettes	White Hot, Black Hot, Fusion, Rainbow, Globow, Ironbow1, Ironbow2, Sepia, Color1, Color2, Ice-Fire, Rain, and OEM	
Remote Control	Wireless (Activates/ Deactivates the scope in Standby Mode)	
Interface	Micro-USB (External Battery Pack); S620 connector (Power In, Analog Video In/Out, Digital Video Recorder)	
Battery Type	Two CR123A 3V Lithium batteries or two CR123 type rechargeable batteries with voltage from 3.0V to 3.7V	
Battery Life (Operating)	Up to 4 hr at 20°C	
External Power Supply	External battery pack via micro-USB port	
Environment Rating	Waterproof	
Operating Temperature	-40°C to +50°C (-40°F to +122°F)	
Storage Temperature	-50°C to +70°C -58°F to +158°F)	
Weight	0.81 kg (1.8 lbs)	0.7 kg (1.5 lbs)
Dimensions	217 × 71 × 81 mm (8.5 × 2.7 × 3.1 in)	208 × 71 × 81 mm (8.2 × 2.7 × 3.1 in)

Specifications are subject to change without notice.

PVS-7

NIGHT VISION GOGGLES

The PVS-7 is widely recognized for its unsurpassed dependability and ergonomic design. This U.S. Military-grade night vision goggle system has repeatedly proven its worth in combat, and is the highest-quality AN/PVS-7 B/D system on the market. The PVS-7 can be outfitted with high-performance Gen 2+ and Gen 3 image intensifier tubes (available in Green phosphor or P45 white phosphor).

The PVS-7 is equipped with Automatic Brightness Control (ABC) to adjust image brightness in changing light conditions to maintain image definition and clarity. The built-in infrared illuminator provides a light source beyond the visible spectrum to enable the user to operate in complete darkness without being detected.

Additionally, the PVS-7 has a bright light cutoff feature to protect the image tube from sources of intense light, and a flip-up shut-off feature that can be used with the optional helmet mount system. The PVS-7 has two LED indicators in the eyepiece for the IR illuminator on and low battery indicator.

Lightweight, tough, and versatile, the PVS-7 can be handheld, or mounted to the user's head/helmet. It is compatible with afocal magnifier lenses for superior long-range viewing.



- Compact, rugged design
- Waterproof
- Head or helmet-mountable for hands-free operation
- Ergonomic, simple, easy-to-operate controls
- Built-in Infrared illuminator
- Limited 3-year warranty



Equipment described herein is subject to US export regulations and may require a license prior to export. Diversion contrary to US law is prohibited.

SPECIFICATIONS

Image Intensifier Tube	Gen 2+ or Gen 3
Magnification	1x
Lens System	27 mm; F/ 1.2
FOV	40°
Focus Range	0.2 m to infinity
Diopter Adjustment	-6 to +2 diopters
LED Indicators (in the FOV)	- Low Battery - IR On
Automatic Brightness Control	Yes
Bright Light Cut-Off	Yes
Infrared Illuminator	Yes
Battery Type	2 AA Alkaline or 1 Lithium (BA-5567/ U)
Battery Life (Operating)	Up to 60 hours at 20°C
Operating Temperature Range	-40°C to +50°C (-40°F to +122°F)
Storage Temperature Range	-50°C to +70°C (-58°F to +158°F)
Weight	0.68 kg (1.5 lb)
Overall Dimensions	162 × 152 × 76 mm (6.4 × 6.0 × 3.0 in)
Package Includes	Night Vision Goggles, Head Mount Assembly, Medium & Thick Brow Pads, Eye Cups, Lens Cap/Daylight Filter, Shoulder Strap, Lens Paper, Sacrificial Window, Demist Shields, Manual, Soft Carrying Case

Specifications are subject to change without notice.
Images are for illustration purposes only.

OPTIONAL EQUIPMENT

AGM Sioux850 Long-Range Infrared Illuminator comes included with Rechargeable Battery and Charger
(P/N 501SIOUX850IR1)

AGM Afocal Magnifier Lens Assembly, 3X
(P/N 61023XA1)

AGM Afocal Magnifier Lens Assembly, 5X
(P/N 61025XA1)

AGM 7.4x Lens for PVS-7
(P/N 61018XL1)

MICH Helmet Mount Assembly
(P/N 6103MHH1)

PASGT Helmet Mount Assembly
(P/N 6103PHM1)

Hard Case
(P/N 6610HCS1)

dji ENTERPRISE



DJI MAVIC 3 ENTERPRISE SERIES

Your Everyday Commercial Drone



The Mavic 3 Enterprise redefines industry standards for small commercial drones. With a mechanical shutter, a 56× zoom camera, and an RTK module for centimeter-level precision, the Mavic 3E brings mission efficiency to new heights. A thermal version is available for firefighting, search and rescue, inspection, and night operations.

Two Models, Countless Applications

DJI MAVIC 3E

Wide: 4/3 CMOS, 20 MP, Mechanical Shutter

Zoom: Equivalent Focal Length 162mm, 12MP, 56× Hybrid Zoom

DJI MAVIC 3T

Wide: Equivalent Focal Length 24mm, 48MP

Zoom: Equivalent Focal Length 162mm, 12MP, 56× Hybrid Zoom

Thermal ^[1]: DFOV: 61°, Equivalent Focal Length 40mm, Resolution 640 × 512

Premium Camera Performance

- HD Wide Camera
- Smart Low-Light Photo
- Thermal
- Synchronized Split-Screen Zoom

Compact and Portable

- Lightweight 915g/920g airframe ^[2]
- Compact body that fits in the palm of your hand
- Perfect for beginners and veteran pilots alike

Ultra-long battery life

- 45-min max flight time ^[3]
- 100W charging hub for fast charging batteries
- 88W drone direct charging

Flagship Flight Safety

- Wide-angle lenses for omnidirectional obstacle sensing with zero blind spots ^[4]
- Advanced RTH
- APAS 5.0 for automatic rerouting around obstacles ^[5]

Abundant Accessories

- DJI RC Pro Enterprise ^[6]
- RTK Module ^[7]
- Loudspeaker ^[7]
- D-RTK 2 Mobile Station ^[7]

Full Software Suite

- DJI Pilot 2
- DJI FlightHub 2
- DJI Terra
- DTAT 3.0

1. DO NOT expose the thermal camera lenses to strong sources of energy such as the sun, lava, or a laser beam. Otherwise, the camera sensor may be burned leading to permanent damage.

2. DJI Mavic 3E (with propellers) 915 grams; DJI Mavic 3T (with propellers) 920 grams.

3. Measured at 32.4 km/h uniform speed at sea level in a windless environment until battery was fully drained to 0%.

4. Omnidirectional sensing capability is limited by environmental conditions like weather and electromagnetic interference. Please fly with caution when working in challenging conditions (e.g. wind speeds over 12 m/s)

5. Supported in manual flight mode only. Caution is recommended when flying in hazardous environments.

6. Currently available only with the purchase of DJI Mavic 3 Enterprise Series.

7. Accessories sold separately.



PERSON-PORTABLE GC-MS CHEMICAL IDENTIFIER

FLIR GRIFFIN™ G510



The FLIR Griffin™ G510 Gas Chromatograph Mass Spectrometer (GC/MS) is a versatile, person-portable chemical identifier. It complements presumptive techniques used during emergency missions, by enabling responders to analyze all phases of matter (liquid, solid, vapor) and by performing rapid field-confirmation of chemical hazards. The integrated heated sample probe enables hot zone operators to identify vapor-phase chemical threats within seconds when operated in Survey Mode. The integrated split/splitless injector allows for environmental, forensic, and hazardous material sampling via syringe injection of organic liquids. The 9" on-board touchscreen delivers automated user controls and can be operated while wearing full personal protective equipment downrange. It is built with an IP65-rated enclosure for harsh environments and supports passive defense, interdiction, elimination, and consequence management missions. Long-lasting, on-board batteries ensure every mission is supported from beginning to end.

www.flir.com/G510



MASS SPEC PERFORMANCE REDEFINED

Confidently identify unknowns and take action with guided controls and simple threat alarms

- Lab, gold-standard linear quadrupole mass analyzer
- Full NIST chemical library for field identification and analysis of unknown materials and mixtures
- Simple on-board touchscreen with automated user controls
- Visual and audible alarm confirmation with limited data interpretation
- On-board WiFi and GPS assist in maintaining result defensibility



ULTIMATE CHEMICAL DETECTION TOOLBOX

Versatile in-field sampling options for vapor, liquid, and solid samples

- Vapor sampling probe with rapid-response survey mode
- Integrated split/splitless liquid injector accepts direct injection of organic liquids
- Available Prepress Sample Introduction (PSI) Probe with Touch-And-Go (TAG™) capability for direct analysis of solid samples
- Effortlessly links with SPME and headspace sample collection tools
- High-fidelity, low thermal mass (LTM) GC column for unsurpassed resolution in challenging environments



BUILT FOR EVERYONE, BUILT FOR EVERYWHERE

Completely self-contained and mission-ready from the field to the lab

- IP65-rated, dust-tight and spray-resistant
- Built-in active pumping system eliminates need for an external service module
- Integrated carrier gas, batteries, and training reference videos
- Simple field maintenance activities for increased uptime
- Extensive training, service, and support options available

SPECIFICATIONS

Griffin G510	
Technology	Gas Chromatography/Mass Spectrometry (GC/MS)
Dimensions (L x W x H)	13.25 x 13.25 x 15.75 in (33.7 x 33.7 x 40 cm) - includes batteries, carrier gas, and vacuum system
Weight	36 lbs (16.3 kg) - includes batteries, carrier gas, and vacuum system
Operating Temp / Humidity	32 to 104 °F (0 to 40 °C); <95% relative humidity
Storage Temp	-13 to 131 °F (-25 to 55 °C)
Decontamination	Sealed for Survey Mode operation in hot-zone; IP65-rated enclosure is dust-tight and spray-resistant
Power Supply	100-240V 50-60Hz (220 W max); 19V (DC); 2 x #2590 @ 15V Li Ion batteries (included)
Battery Life	4 hrs in Survey Mode, 2 hrs in Confirmation Mode; hot swappable
Start Up Time	15 minutes to full operation from cold
Calibrant	On-board FC-43 (Perfluorotributylamine)
Carrier Gas	On-board helium; external helium connector, automatic switching (Hydrogen capable)
System Interface	
Display	9" Multitouch Color Display (1280x720 WVGA; 1300 nits brightness)
Alerts	Audible and visual (touchscreen and handheld probe)
Software	GSS Level 1 Touch; multiple user levels
Communication	2 x USB 2.0, Bluetooth 4.0, WiFi 802.11n, Ethernet via USB, integrated GPS
Data Storage	Internal >128GB SSD
Training Requirements	2 hours basic operation; 8 hours Operator Certification
Sampling & Identification	
Sample Phase	Solid, liquid, and vapor
Sample Introduction	Heated Sample Probe (included standard): - Vapor survey mode via Membrane Introduction Mass Spectrometry (MIMS) Inlet - Vapor confirmation via Internal Dual-Bed Preconcentrator Split/splitless injector (included standard) accepts: - Direct liquid sampling (organic solution) via syringe - Liquid extraction via SPME fiber or PSI-Probe w/ Gerstel Twister™ * - Solid PSI-Probe™ thermal separation via TAG™ * *optional accessories
Threats	Detects and identifies explosives, narcotics, CWAs, TICs, environmental pollutants, and other chemicals
Standard Reference Database	NIST/EPA/NIH Mass Spectral Library
Sampling & Analysis	Full identification in 4-15 minutes for most chemicals; identification within seconds (near real-time) when operating in Survey Mode

Mass Spectrometer	
Mass Analyzer Type	Linear quadrupole mass filter
Mass Range / Resolution	15-515 m/z; 0.7 amu @ FWHM
Ionization Type / Source	Electron Impact Ionization; non-radioactive ionization source
Detector	Electron Multiplier
Vacuum System	Self-contained miniature turbomolecular & diaphragm pumps
Dynamic Range	7 decades
Detection Limit	PPM (parts per million) – PPT (parts per trillion)
Gas Chromatograph	
LTM-GC Column	DB-5MS (15 m x .18 mm x 0.25 µm); others available
Temperature Range	Programmable 40 to 300 °C; ramping of 100 °C/min



Specifications are subject to change without notice.
 For the most up-to-date specs, go to www.flir.com



Multi-Threat Trace Detection and Identification

MULTI-THREAT DETECTION

MX908™ leverages high-pressure mass spectrometry™ (HPMS) to deliver dramatically enhanced sensitivity and broader threat category coverage. This second-generation tool increases mission support with unmatched flexibility and trace detection power for elite responders in chemical, explosive, drug and priority hazmat scenarios.

RELIABLE FIELD ANALYSIS

With the enhanced selectivity of HPMS, users can conduct field analysis of unknown substances at trace levels to generate actionable intelligence in real time. The MX908 allows operators to rapidly assess threat levels, establish reliable probable cause, and prioritize investigatory resources accordingly, all while reducing operator exposure.



MISSIONS:

- Drug Interdiction
- Clandestine Laboratory Exploitation
- EOD
- Border security
- HazMat response
- Checkpoint security
- Postal security
- Event security

THREAT CATEGORIES:

- Fentanyl/Synthetic Opioids
- CWA
- Emerging threats
- Explosives
- TIC/TIM
- Precursors

OPERATIONAL STRENGTHS:

- Trace-level vapors, solids and liquids

ATTRIBUTES:

- Fast start up
- Rapid analysis
- Trace detection (low - mid nanograms)
- Powered by mass spectrometry
- Heightened sensitivity and selectivity
- Unmistakable audio and visual alerts
- Simple interface
- Low maintenance





MX908 Mission Modes enhance performance for specific mission objectives.

Drug Hunter is a mission mode for the detection of drugs such as: fentanyl and fentanyl-analogues, along with other high priority controlled substances.



Drug Hunter unlocks detection capabilities for more than 2000 fentanyl variants.

This Mission Mode future-proofs your MX908 against the ever-changing Fentanyl analog landscape with a novel classification algorithm that sets MX908 apart from any library-based techniques.

SPECIFICATIONS

Size	29.8 x 21.6 x 12.2 cm (11.8 x 8.5 x 4.8 in)
Power	Replaceable, hot swappable batteries with >3 hours of continuous operation (2 spare batteries included)
Display	Adjustable ultra-bright backlit display for direct sunlight and nighttime conditions, 12.7 cm (5 in)
Weight	≤4.3 kg (9.5 lbs); varies based on module, accessories
Ionization Source	Non-radioactive, internal ionization, variable energy, dual polarity
Sample Introduction	Continuous gas/vapor analysis; rapid trace-to-bulk solid/liquid analysis via thermal desorption swabs
Alarm Type	Audio and visual for both detection and identification
Software	Embedded, self-contained, on-board analytics
Decontamination	IP-54 rated, chemical resistant housing spray/splash and wipe down
Operating Temperature	0°-40° C (32°-110° F)
Storage Temperature	-20°-60° C (-4°-140° F)
Ruggedness	MIL-STD-810G



MX908 is rugged and meets the requirements for use in harsh environments.



MX908 is equipped with modular accessories for ease of transition between solid and vapor sample types.

▶ ALL	1	
▶ CW AGENTS	▶ 1-phenyl-2-propanol	///
▶ CWA PRE/DEG	2	
▶ DRUGS	▶ 2,4-toluene diisocyanate	///
▶ DRUG PRECURSORS	▶ 2-(bromoethyl)benzene	///
▶ EXPLOSIVES	▶ 2-(diethylamino)ethanol	///
▶ FENTANYLS	▶ 2-(diisopropylamino)ethanol	///
▶ INDUSTRIAL	▶ 2-chloroethyl ethyl sulfide	///
▶ PRIORITY TIC	3	
	▶ 3-methylfentanil	///
	▶ 3-quinuclidinol	///
	a	

The enhanced selectivity of MX908 allows for even broader threat category coverage.

PVS-14

NIGHT VISION MONOCULAR



The AGM PVS-14 Night Vision Monocular is a rugged, lightweight, multi-purpose night vision device that has repeatedly proven itself in combat. The PVS-14 design was originally commissioned by the United States Military to enable nighttime operations. This monocular is used globally in some of the most challenging environments. The PVS-14 can be used as a handheld device, or mounted on the included head harness. With the proper accessories, it can also be mounted to combat helmets, providing night vision capabilities to daytime optical sights. The PVS-14 monocular conforms to 810G Military standards and demonstrates the highest quality form and function.

The PVS-14 monocular is a full-featured unit. Weighing less than 12.4 ounces/ 0.32 kilograms. The unit includes manual gain control, an automatic bright light shut-off feature, and a built-in Infrared (IR) illuminator. The bright light shut-off feature ensures that the high-quality photocathode tube is protected. AGM's PVS-14 includes an array of optional accessories to support virtually any operation.

- Compact, rugged design
- Waterproof
- Head or helmet-mountable for hands-free usage
- Manual gain control
- Ergonomic, simple, easy-to-operate controls
- Built-in Infrared illuminator and flood lens
- Limited 3-year warranty



Equipment described herein is subject to US export regulations and may require a license prior to export. Diversion contrary to US law is prohibited.

SPECIFICATIONS

Image Intensifier Tube	Gen 2+ or Gen 3
Magnification	1x (3x and 5x optional)
Lens System	26 mm; F/1.2
FOV	40°
Focus Range	0.25 m to infinity
Diopter Adjustment	-6 to +4 diopters
LED Indicators (in the FOV)	- Low Battery - IR On - Excessive Light Conditions
Manual Gain Control	Yes
Bright Light Cut-Off	Yes
Infrared Illuminator	Yes
Battery Type	One AA Alkaline
Battery Life (Operating)	Up to 50 hours at 20°C
Operating Temperature Range	-51° C to +49° C (-60° F to 120° F)
Storage Temperature Range	-51° C to +85° C (-60° F to 185° F)
Weight	0.32 kg (12.4 oz)
Dimensions (w/o lens cap and eyecup)	114 x 63x 69 mm (4.5 x 2.5 x 2.7 in)
Package Includes	Night Vision Monocular, Head Mount Assembly, Brow Pad, Eye Cup, Helmet/Head Mount Adapter, System Soft Carrying Case, Daylight Filter, Shoulder Strap, Lens Paper, Diopter Lens Cap, Sacrificial Window, Demist Shield, Manual, Battery

Specifications are subject to change without notice. Images are for illustration purposes only.

OPTIONAL EQUIPMENT

AGM Sioux850 Long-Range Infrared Illuminator comes included with Rechargeable Battery and Charger
(P/N 501SIOUX850IR1)

AGM Afocal Magnifier Lens Assembly, 3X
(P/N 61023XA1)

AGM Afocal Magnifier Lens Assembly, 5X
(P/N 61025XA1)

MICH Helmet Mount Assembly
(P/N 6103MHM1)

PASGT Helmet Mount Assembly
(P/N 6103PHM1)

AGM 51 degree FOV Lens Kit PVS-14/PVS-14 Omega
(Kit includes Objective Lens and Eyepiece)
(P/N 610150K1)

Hard Case
(P/N 6610HCS1)





Supreme Pro-X

75302-X / 75302-XL / 76302-X

The Supreme Pro-X features high amplification with natural, realistic sound to provide excellent protection in noisy environments. Two separate, waterproof microphones provide optimum stereo effect and location of sound direction. By wearing Supreme ear muffs you can communicate face-to-face as well as hearing commands and instructions without removing the hearing protector, even when others are shooting. The removable headband is washable, while the slim cups offer a lightweight, attractive design.

Features

- Black or Green Cups shaped to fit both right hand and left hand shooters
- Two separate waterproof, level dependent [82dB(A) max] microphones that reproduce the ambient sound
- Positive, three-button volume and power control
- Low battery warning and save functions (~600 hrs of battery life)
- AUX 3.5 mm mono jack plug input permits connection to external sources, such as communication radios and mp3 players
- Requires 2-AAA batteries (included)
- Available as a foldable headband or as a neckband, also available with a leather headband



Product Code: 75302-X



Product Code: 75302-XL



Product Code: 76302-X

**Optional*

Gel Ear Seals

Product Code: 60092



Attenuation Data			
Headband			
SNR: 25dB	H: 28dB	M: 21dB	L: 16dB
Neckband			
SNR: 24dB	H: 26dB	M: 21dB	L: 15dB

S400

**FLAGSHIP WORKPIECE, BORN
FOR HIGH INDUSTRIAL EFFICIENCY**



Multi-machine
Relay Networking



Millimeter Wave Radar
Barrier Avoidance



63mins Max
Flight Time



Megapixel
Infrared Camera



Professional
& Powerful



21TOPS Computing
Power Camera

63mins

Max Flight Time

3000g

Max loading

5000m

Max Take-off Altitude

Level **7**

Max Wind Resistance

High-capacity
Polymer battery

Aviation-grade magnesium alloy material

Side millimeter wave radar

Carbon fiber arm

Binocular perception system

Carbon fiber tripod

Multiple mount interface

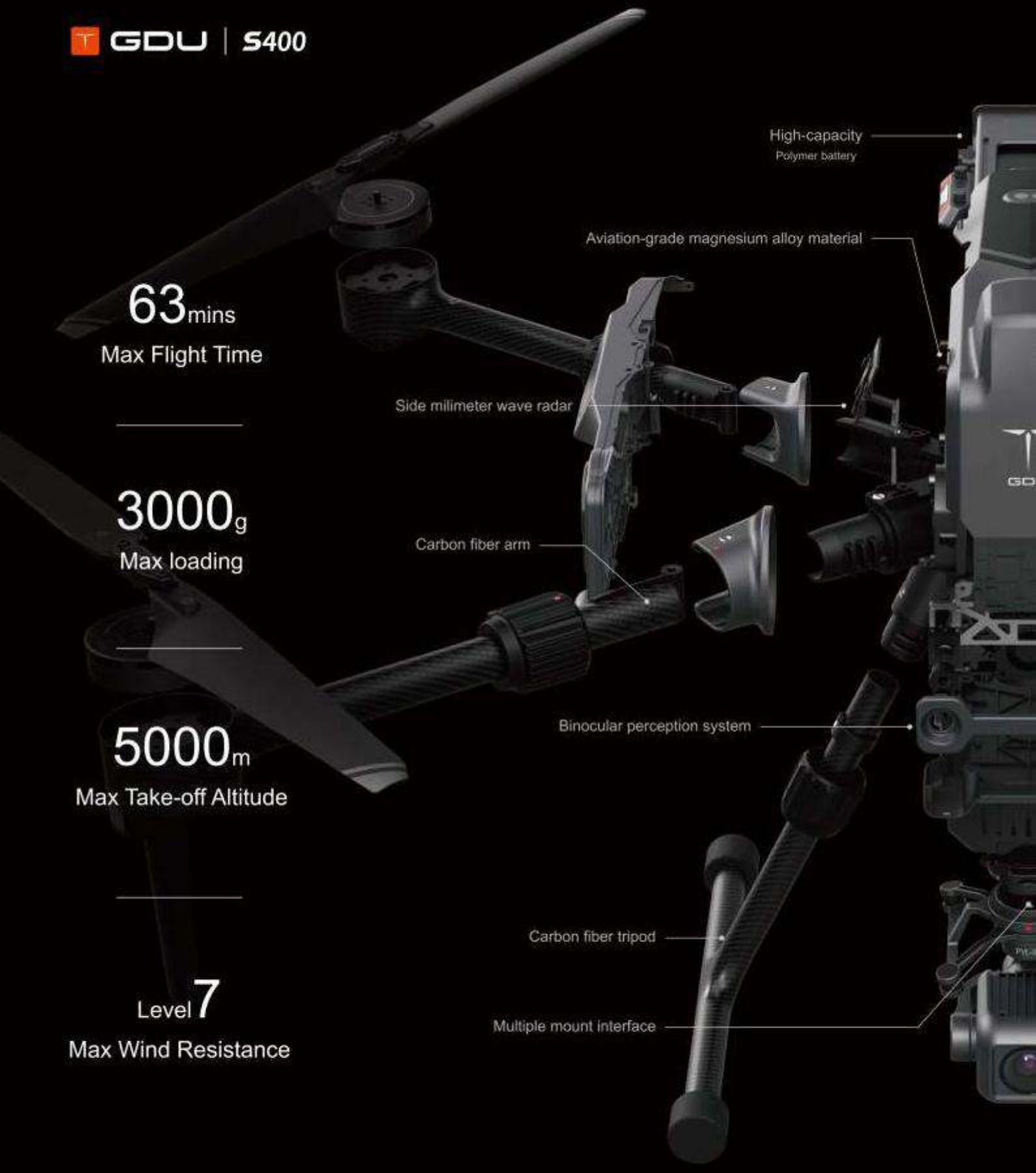

High-end, Professional UAV Pioneer

Upward thermal perception system

Airborne AI edge computing module;
Refine, auto&visual

RTK

Centimeter-level positioning accuracy

Efficient and lightweight power system

Side millimeter wave radar

Front millimeter wave radar

Foldable body

Safe, stable, easy to carry

S400

S400 is a brand-new light industrial-grade flagship UAV launched by GDU Tech. It integrates a number of cutting-edge technologies of UAV systems, and has made major breakthroughs in stability, autonomy, and intelligence. With the industry-leading UAV cross-line-of-sight networking technology, it can easily realize the intelligent interconnection of multiple UAVs and control equipment, and double the operation efficiency.

The frame is made of magnesium alloy, the body is foldable, safe and stable, and easy to carry. Equipped with millimeter-wave radar and integrated binocular perception system, it can achieve omnidirectional obstacle avoidance. At the same time, the on-board AI edge computing module ensures the refinement automation and visualization of the inspection process.

Compatible Payloads



PQL01 quadra-sensor camera

It perfectly combined wide-angle, visible light, zoom, infrared thermal camera and the long-distance precise laser camera, and the intelligent linkage and complementary advantages between multiple types of sensors provide more power for the industrial drones, break the visual limitations, and not missing area and details. A UAV can be applicable for multiple applications.

Zoom camera
Thermal camera
Temperature measurement mode
Temperature measurement range
Wide-angle camera
Laser ranging
Weight
Dimensions
Stabilization accuracy

Photo resolution: 48mega pixels, 18X optical zoom
Resolution: 640*512; 13mm Fixed focus thermalization
FullRegional
-40 C ~150 C (high gain) -40 C ~550 C (low gain)
Photo resolution: 48mega pixels
Measuring range 0~1500m, Wavelength 905nm
< 500g
153.5mm*163mm*179.7mm
±0.005°



PDL-1K dual-sensor camera

It combines 1K infrared, 1-inch CMOS visible light camera, resolution is up to 48mega pixel, and can catch clear picture in day or night, and is widely used.

Thermal camera
Optical camera
Temperature measurement mode
Temperature measurement range
Temperature measurement accuracy
Weight
Dimensions

Photo resolution: 1280*1024
Photo resolution: 48mega pixels
FullRegional
-20 C ~150 C / 0 C ~550 C
±2 C or ±2% (Max)
< 1200g
178mm*157.5mm*193.3mm



PDL-300 dual-sensor camera

The details of the shooting target can be caught clear, whether it is day or night. It can be used clearly at night, it meets industrial applications high standards on image quality and light weight.

Thermal camera
Optical camera
Temperature measurement mode
Temperature measurement range
Temperature measurement accuracy
Weight
Dimensions

Photo resolution: 640*512
Photo resolution: 48mega pixels
FullRegional
-40 C ~150 C / -40 C ~550 C
±2 C or ±2% (Max)
< 388±5g
103.4mm*107.6mm*129.6mm



PVL-8K camera

It can easily take pictures up to 48mega pixels and video up to 4K@30fps, and perfectly applicable in safety, forestry, transportation, power grid.

Camera
Sensor size
Focal distance
FOV
Weight
Dimensions

Photo resolution: 48mega pixels
1 inch
12.8mm
FOV63.4°
< 250g
56mm*59mm*102mm

LiDar



Oblique camera



Megaphone



Floodlight



Gas detector



Product Parameter

Index	Content
Unfolded dimensions	549 × 592 × 424mm(exclude paddle)
Folded dimensions	347 × 367 × 424mm(including tripod&paddle)
Max take-off weight	7kg
Symmetrical motor wheelbase	725mm
Max loading	3kg(Max loading, Max safe flight speed 15m/s)
Max horizontal flight speed	23m/s (sport mode, horizontal /no wind)
Max take-off altitude	5000m
Max wind-resistance level	Level 7
Max flight time	63mins(no wind/light wind, hovering test battery runs from full capacity to out of capacity)
Hovering accuracy(GNSS)	Horizontal:±1.5m(GNSS on) Vertical: ±0.5m(GNSS on)
Hovering accuracy(Vision positioning)	Horizontal:±0.3m(vision positioning on)
Hovering accuracy(RTK)	Horizontal:±0.1m(RTK on) Vertical:±0.1m(RTK on)
Positioning accuracy	Vertical:1cm+1ppm Horizontal:1.5cm+1ppm
IP level	IP45
Video transmission range	15km(Flying at an altitude of 200 meters without any interference)
Omnidirectional barrier avoidance	Obstacle perception range(Buildings, trees, utility poles, towers over 10m) Front:0.7m~40m (80m max detectable distance for large metal objects) Left&right:0.6m~30m (40m max detectable distance for large metal objects) Up&down&back:0.6m~25m Work environment: rich texture on the surface, sufficient lighting conditions (>151ux, indoor fluorescent light normal illuminate)
AJ function	Target inspection, follow, recognition
Flight safety	ADS-B function, Can sense surrounding civil aviation aircraft information for evasion

GDU Auto UAV Dock

Accelerating aerial infrastructure, empower UAV auto mode

GDU launched UVER Smart UAV Dock, which integrates functions such as automatic cruise, automatic take-off&landing, fast charging, high-frequency normal or sudden flight, and intelligent data identification, effectively saving the commute cost of UAV operations. It effectively solve he problems of high commute cost, low efficiency and assist users in various industries to achieve fully autonomous flight and automatic operations



S400 Inspection UAV

60mins flight time

AI smart recognition

80m omnidirectional barrier avoidance

Industrial top-tier relay network



4-in-1 camera



8K camera



Megaphone



Floodlight



Product Parameter

Parameter	Content
Dimensions	1460 × 1460 × 1590mm
Weight	Aluminum alloy 130KG
Communication mechanism	Broad band/OPGW/4G/5G
Compatible UAV	S400
Work mode	Auto charging
Landing positioning	RTK, vision recognition
Video transmission&control distance	10KM/5G infinity
Work temperature range	-20℃-60℃
Work humidity range	≤95%
Max altitude	4000m
IP level	IP54
Function	UPS uninterruptible power supply, night landing
Power consumption	1400W (max) /500W (average)
Temperature detection	Wind speed, rainfall, temperature, humidity, air pressure
AI function	Target detection, follow, recognition
Back-end control mechanism	WEB/APP
Prep time	2mins
SDK development	Yes







FIRELIGHTING

FIREDRAGON

The green & clean ecofriendly fuel

The cleanest solid fuel available today:

No soot ✓

No toxic fumes ✓

All weather

Rain, snow, extreme cold or searing heat, FireDragon performs in the most extreme weather conditions 

Low luminosity 

Emits very little light when burning so as not to give away your position to the enemy

Easy to light 

With just a spark, lighter, flint striker or match

Packed safely with food 

Easy to store and handle and can be safely packed together alongside food. Unlike many other cooking fuels, FireDragon does not contaminate or taint food

Long shelf life 

FireDragon has a shelf life of 5+ years

Lightweight 

Extremely lightweight with each block weighing in at only 27 grams. The blocks can be easily carried and stored in pockets, backpacks or webbing

Hand cleanser 

FireDragon is a natural disinfectant and can also be used as a waterless soap. Ideal when in the field just before cooking and eating



All Weather



**Hand
Cleanser**



A waterproof, easy to light, non-toxic, and powerful cooking fuel



Eco friendly

Made from sustainable, naturally derived bio-ethanol



Non-toxic & odourless

Unlike other cooking fuels, FireDragon burns without any noxious or toxic fumes. It can also be used indoors (with suitable airflow)



Compatible with most cookers

Can be used with a variety of portable cookers



Fast boil & long burn

A block of fire dragon burns for approximately 8 minutes (2 blocks - 12 minutes) and boils 500ml of water in just 5 minutes



Air transportable

Safe to be packed and transported on cargo



High calorific value

Of 29,000 (kj/kg)



Clean burn

Burns with very little soot or residue so doesn't dirty cooking equipment



Made in the UK

Sourced from British grown grain stocks and made in South Wales



Patented

Unique patented technology granted worldwide. There is no other cooking fuel like it on the market



Quick & Easy
to Light



Clean Burn

FIRELIGHTING

FIRE DRAGON



FIREDRAGON SOLID FUEL



A new, innovative & environmentally friendly solid fuel

Non-toxic and odourless

Highly effective, high burn fuel

Easy and quick to ignite

Very little soot given off, so doesn't dirty your cooking pot or mess tin

Easy to store and handle

Each block will burn for about **8 minutes**



Will light & burn **even when wet**

Can be used with a **variety of cookers**

Made from **sustainable, natural biofuel**

Air Transportable:
UN Class 4.1 Packing Class III

- NON-TOXIC ✓
- ODOURLESS ✓
- 100% NATURAL ✓

Code	CN336G
NATO	NSN-9110-99-426-2694
	6x 27 grams (0.9oz)
	40 x 67 x 25mm (1.5 x 2.6 x 1")



Our lightweight, easy to open **military packaging**

In the driving rain, the freezing Arctic, at high altitudes or searing heat, FireDragon will perform in the most extreme conditions



FIREDRAGON GEL FUEL

Easy and clean to use



Our all-weather gel biofuel derived from FireDragon Solid fuel technology

Made from a high purity of ethanol, FireDragon gel fuel can be used in multi-fuel outdoor cooking stoves, and barbecues, as well as for fire lighting

Ideal in the outdoors to cook your rations and boil your brews quickly, safeguard your health, while protecting the environment

Research shows that FireDragon boils water quicker than all other non-gas fuels

Code	CN348A	CN349A
	200 ml	1 litre



-  @FireDragon_fuel
-  @FireDragonfuel
-  @FireDragonfuel

COOKING

FIRE DRAGON



Easy to use

Waterproof

Compact

Reusable

MOD Issue

Efficient

Lightweight

Comes with
attachable
wind shield

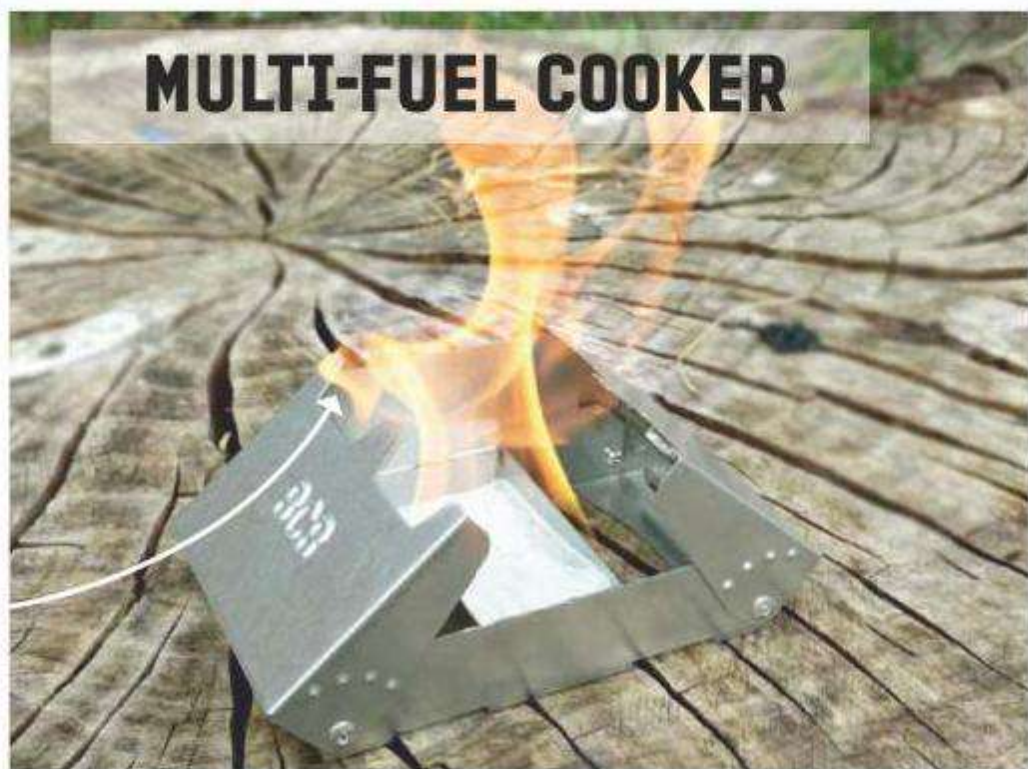

This high quality cooker is made from aluminium, and is small and lightweight

The central fuel receiver helps to improve the burn efficiency so improving your cooking time and reducing the amount of fuel you need. You can store 3 FireDragon solid blocks inside the folded closed stove. Ideal while carrying and storing.



(FireDragon fuel tablets not supplied)



Code	CN337
NATO	NSN-7310-99-587-4226
	110 grams (3.8oz)
	11.5x7x2.5cm (4.5x2.7x0.9")



The FireDragon Mini Cooker is a smaller, lighter alternative to the FireDragon multi-fuel cooker

- ✓Lightweight
- ✓Compact
- ✓Robust

The metal can be folded to suit the size of different cooking pots

In ideal cooking conditions the wind shield and vent can be adjusted for a more intense burn

Two FireDragon fuel tablets can be stored in the cooker to save storage space while travelling

Code	CN360
	40 grams (1.4oz)
	7x5x4cm (2.7x1.9x1.5")

MRE - MINI COOKER



(FireDragon fuel tablets not supplied)

COOKING SET MKIII







This new and improved cooking set featuring **strong, lightweight and high quality material components**



Includes:

- Silicone cup lid (see page 14)
- Canteen water bottle
- Aluminium cooking cup
- Aluminium multi-fuel cooker



Complete Cooking Set

Code	CN030
	510 grams (18oz)
	23x12.5x9cm (9x4.9x3.5")
	152 grams (5.4oz)
	12x14x10cm (4.7x5.5x3.9")
	152 grams (5.4oz)
	8.5x12.5x9cm (3.3x4.9x3.5")

	206 grams (7.3oz)
	19x12x8cm (7.4x4.7x3.1")

COOKING

THE DRAGON MULTI-FUEL COOKING SYSTEM

A strong all-in-one 5 piece cooking set



Each item fits neatly inside the other, making the entire cooking system compact and easy to carry

Hard-anodised metal cup is easy to clean

Multi-fuel cooker works perfectly with our FireDragon fuel, available as solid or gel

The pouch can be molle mounted onto belts, rucksacks or body armour - comes in black or multicam



Complete Cooking Set	
Code	CN017C  CN017B 
	838 grams (29.6oz)

Drinking Cup

Heavy Duty Water Bottle

Cooking cup

Multi-fuel Cooker

Pouch

You may like to add the silicone lid - see page 14



THE DRAGON MULTI-FUEL COOKING SYSTEM:



All items can be purchased separately:

Multifuel Cooker		Cooking Cup		Drinking Cup		Carrying Pouch		Water Bottle	
Code	CN006	Code	RP540C	Code	CR244B	Code	CA815BLK	Code	CR244B
	180 grams (6.3oz)		190 grams (6.7oz)		110 grams (3.9oz)		118 grams (4.2oz)		140 grams (4.9oz)
	11.4x10.2x8.9 cm (4.5x4x3.5")		950ml		580ml		11.7x8.2x5cm (4.6x3.2x1.9")		1 litre



COOKING

Constructed of high-grade stainless steel. The cup canteen is designed to fit beneath the NATO water bottle as part of the Safetystyle Complete Cooking System



Available with a black PTFE coating which makes it easier to clean

Doubles as a cooking pot

Code	CN540 ● CN540B ●
NATO	NSN- 6850-99-798-5980 ● NSN- 8465-99-721-3131 ●
	290 grams (9.6oz)
	13.7x10.2x10mm (5.3x4x4")
	750ml (1.58 pints)

CUP CANTEEN



DRAGON COOKER



Multi-fuel

Internal chimney helps to improve burn efficiency

Vent hole helps to retain as much heat as possible and funnel the airflow for effective fuel burn

Code	CN006
	152 grams (5.3oz)
	12.5x11x8cm (4.9x4.3x3.1")

Heavy duty material



Screw top closure

British army style

Plastic cup with handle

Issue (58 pattern)

Code	CR244A CR244B (NATO)
NATO	NSN- 8465-99-9736665 (CR244B)
	227g (8oz)
	Mug - 500ml (16.9 fl oz) Bottle - 950ml (32.1 fl oz)

WATER BOTTLE & MUG



AIRBOURNE COOKING CUP MKIII





- Aluminium is quick to heat
- Heat retention indent on bottom increases the surface area so the contents cook quicker
- 2 Steel folding handles

Shaped base with a larger surface area to generate as much heat as possible

Hard anodised - easier to clean

Light weight aluminium

Larger than issued cup canteen



Code	CN540D
	204 grams (7oz)
	13x10x11.5cm (5.1x3.9x4.5")

High temperature silicone lid

Improves heat retention

Stops debris from an open fire getting into cup

Expands on heating to give a good tight fit

Code	RP009D
	37 grams e (1.3oz e)
	14.5x10cm (5.7x3.9")



SILICONE CUP LID



DRAGON COOKING SYSTEM POUCH



- Molle fastening pouch for the complete cooking system
- Available in multi-camo print or black
- Tough, durable material

Code	CA815M 
	CA815BLK 
	32 grams (1.1oz)



ALL-STAR
ENERGY
PUREE BARS

24 HOUR MRE RATION

The 24 hour pack is formulated to provide 3000 to 4000 kcal with a range of meals, beverages and snacks to compliment the main entrees.

A typical pack would include porridge oats or granola for breakfast, tea or coffee, crackers cheese and biscuits. The main meal would have an entrée and a starch with an energy bar or fruit.

The evening meal could also include a soup, an entrée and a snack with tea and coffee to follow

Code	CP020
	1.6kg (3.5lbs)
	26.4x17.6x8.6cm (10.4x6.9x3.4")

Vacuum packed

3 Year shelf life

Energy: 409 kcal

More flavours available

Code	RF0014R (Raspberry) RF001T4 (Cherry)
	84 grams (3oz)
	16x6x1.5cm (6.3x2.4x0.6")

MILLENNIUM ENERGY BAR





BARLEY SUGAR RATION



Barley sugar sweets sealed in a waterproof tin

Long shelf life as they are double hard boiled

The tin can be used as an emergency cooking pan

Code	MM108
NATO	NSN-8970-99-700-2104
	170 grams (6oz)
	11x8.2x2.8cm (4.3x3.2x1.1")





JETSTREAM



Closed cell foam lined pouch for **insulation and protection**

Lightweight shoulder straps are removable so the system can be attached to larger pack yokes and makes it easier to fit into your rucksack

Polyamide fabric available in **multicam or black**

Easy access double zip extends down the pack and provides opening for the drinking tube over the shoulders or under the arm

Strong: 500 denier multicam cordura

Easy to use mouth piece & cap

Attachments: 6 'D' rings and 4 side release buckles, to attach to the outside of payload day sack

Top and side double heavy duty zip



Contains the 3 litre reservoir shown below

Code	CR802M ● CR802B ●
	280 grams (9.8oz)
	3 litres (5 pints)

3 LITRE REPLACEMENT RESERVOIR

Protective dust cover

Material: 0.4 mm TP

Slide-Seal™ Top - opens wide and seals tight

Durable, built for a lifetime of tough use, NoLeak™ Lifetime Guarantee

Surge™ Valve - silicone, 45 degree, high flow bite-valve with twist shut off

Hydrafusion™ Tube - ballistic TPU extrusion to insulate and protect

Inline filtration compatible

Plug-N-Play™ Connector - quick disconnect for convenient tube removal





Large top opening for ease of cleaning

100% BPA and PVC Free

Quick removable connection

Can be frozen or filled with warm water (max temp 140 °F / 60 °C)

Reversible and anti-microbial to help prevent bacteria & mold

Code	CR816
	113 grams (4oz)
	44x16.5cm (17.3x6.5")
	Capacity: 2.8Kg (100oz)



AQUA LOO/MEDICAL POUCH

A useful multicam pattern pouch complete with pockets, zipped compartments, handles, and a hanging clip. Ideal for medical supplies and/or toiletries



Cordura material

Numerous pockets

Code	CS003M
	104 grams (3.6oz)
	Open: 40x18x2cm (15.7x7x0.7")

Contents not included

Both with multiple pockets and hanging clips

COMBAT WASH BAG





Removable Mirror

3 x stuff pouches

1 x large mesh pocket

1 x large zippered pocket

1 x large zippered window pocket

Code	CD416M
	200 grams
	Open: 67x25cm (26.8x10")





DISASTER GRAB BAG

We have developed the Disaster Grab Bag with everything you need packed inside to give you the very best chance of survival of the event of an emergency

40+
ITEMS



- 25 Litre Daysack (Olive) • Safetystyle Survival Instructions • Crusader Cooker MKII • FireFragon Fuel 6 Pack x2 • Fireball Flint & Striker Grand • Tinder Card (Packs 18 Strips / Pack) x2 • Wind & Waterproof Matches x25 • Nightlight x 4 • Collapsible Jerry Can (10 Litre) • Water Purification Tablets (2 x 50) • Salt Sachets x2 • Mess Tin • Plastic Spoon x4 • 2" Mayday Signal Mirror • Howler Whistle • Uni-Com Large Wind Up Torch • Survival Bag - Orange x4 • Paracord • Lifesaver 2 First Aid Kit • Wet Wipes 25pack • Snpaseal bags x10 • Toilet Paper x2 • Main Meals 300g x3 • All Day Breakfast Meal • Waterbottle & Mug

Code	CK024
	3Kg (6.6lb)
	35 x 42 x 23cm (13.7 x 16.5 x 9")



20+
ITEMS

AIR CREW SURVIVAL PACK MK4



Successfully used in conflict and standard issue by Royal Air Force aircrew

This high specification kit is vacuum-sealed in olive foil packets and contained in a flexible olive bag

Code	CK420
NATO	NSN-8465-99-131-4124
	450 grams (16oz)
	18x12x5cm (7x4.7x1.9")

- Water Purifying Tablets • Tinder • Small Tin • Water Carrier Condoms (2) • Fishing Kit • Flint & Striker, Fire Tablets • Wire Saw • Sewing Needles • Vinyl Tape • Sleeping Bag • Nylon Cord • Compass • Candle • Snare Wire • Suspender Clips • Razor Blade • Elastic Band • Instruction Sheet • Foil Blanket (Matt Olive)

PROTECTION





FOIL HYPOTHERMIA BLANKET

The lightest and most compact blanket in our range. It assists in the retention of up to 90% radiant body heat

Lightweight foil sheet

Available in silver/silver or olive/silver



Code	RP041 / RK138
NATO	NSN-7210-99-991-0460
	50 grams (1.7oz)
	202x132cm (84x54")





EMERGENCY SLEEPING BAG

A medium gauge, full size, polythene

Compact and lightweight it is ideal as a shield against the elements or as a waterproof outer layer for a sleeping bag

160 gauge (medium) polythene

Vacuum packed

Code	CL520
	140 grams (5oz)
	10x20x3cm (4x8x1")



CAMOUFLAGE CREAM

EASY TO APPLY, COSMETIC GRADE CAMOUFLAGE PAINT

Available in
four different
colours:

BLACK

CL1493BK

GREEN

CL1493G

BROWN

CL1493BR

TAN

CL1493T

CAMO CREAM TUBES

**SINGLE
COLOURS**



**SAFETYSTYLE FIRST SQUEEZY
CAMOUFLAGE CREAM TUBES FOR EASY
AND CLEAN APPLICATION**



Easy to apply and remove

- Rich concentrated oil based formula
- Cosmetic high quality ingredients
- Non-irritant
- Sweat proof
- Long lasting
- British Quality

	30g (1oz)
	11cm (4.3")

Available in a box of 28

CAMOUFLAGE STICKS



These convenient two-tone camo sticks create pattern disrupting stripes quickly and effectively without the need for a mirror

- Quick drying
- Matte finish
- Easy application • Convenient size and shape

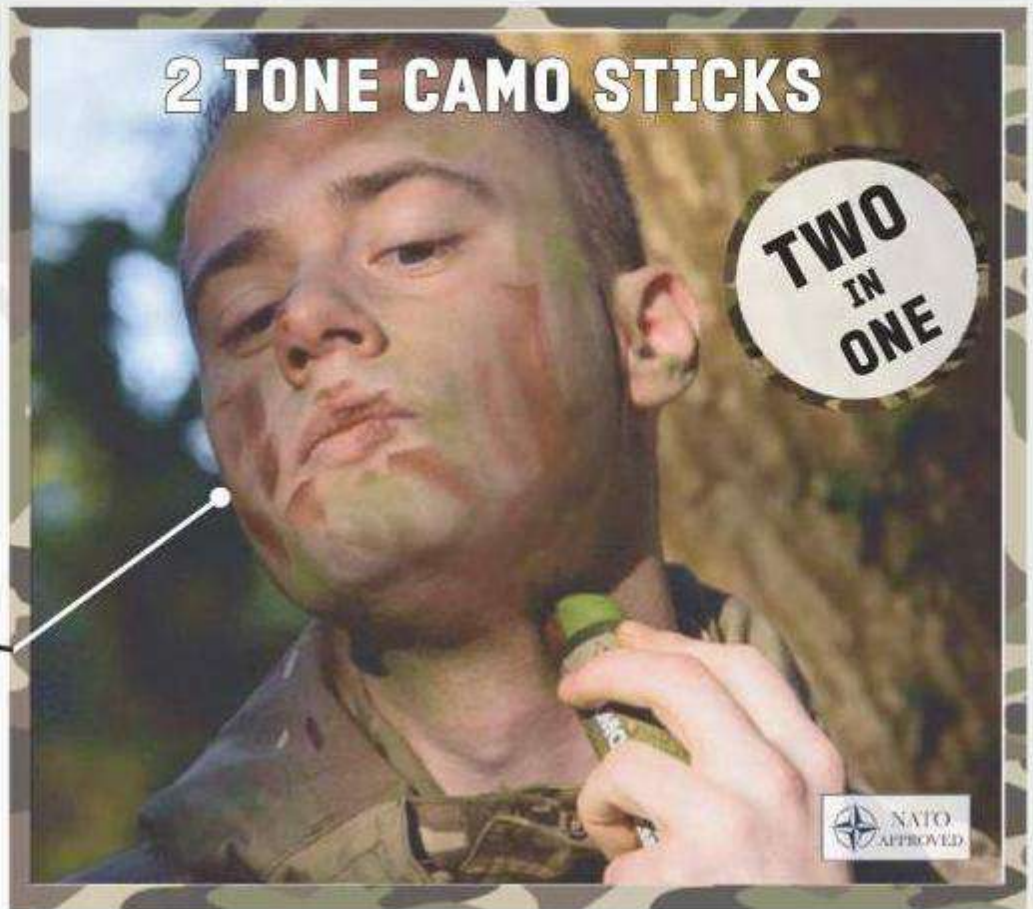

Woodland



CL1480

Desert



CL1480D

Jungle



CL1480B

Arctic



CL1480BW





Easily removed with mild soap or Safetystyle Wet wipes (see page 23)



2 TONE MINI



Jungle



CL1481

Woodland



CL1481B



An even more compact and lightweight version of Safetystyle's 2 tone camo sticks



2 Tone display box



2 Tone Mini display box



Product	2 Tone Camo Stick
NATO	NSN-6850-99-371-1878
	60g (2oz)
	9.3cm (3.7")

Product	2 Tone Mini Camo Stick
NATO	NSN-6850-32-002-0754
	30 grams (1oz)
	6.3cm (2.5")

CAMOUFLAGE COMPACTS



Urban

Softer	Harder
CL1482US	CL1482US

Woodland

Softer	Harder
CL1482AS	CL1482A

Snow Terrain

Softer	Harder
CL1482S	N/A

Multi-Terrain

Softer	Harder
CL1482DS	CL1482D

Tan and loam are also available to special order

Now in 2 different formulas • Non-irritant formula • No anti-oxidants added
 • Not affected by rain • Fast drying • Halal acceptable • Aroma free • Shatter proof mirror • Deep dark colours • Highest European food and cosmetic grade ingredients •

New short term softer formula

Easy on and off

Ideal for colder weather - does not freeze in colder climates unlike other camo creams

Long term harder formula

For longer patrols / exercises

Ideal for warmer weather

Current NATO issue

Deep dark colours

Dries quickly to a matte finish

Used by British and many NATO Forces

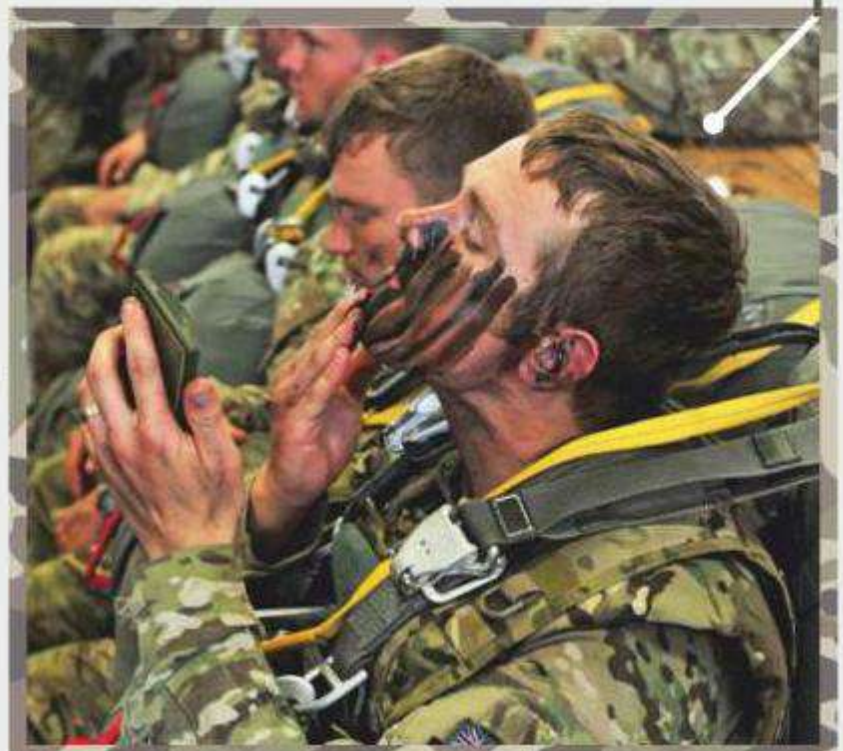

Proven by British Military laboratory tests to „eliminate the NIR capability of skin“



N.B. Skin is a good reflector of NIR, meaning our camo cream won't give away your location



Available in attractive display box of 18

High sun protection



NATO	NSN-6859-99-978-5980
	70g (2.5oz)
	8.5 x 6.5cm (3.3 x 2.6")



CAMOUFLAGES NETS



NATO Issue



Lightweight



Infra Red Reflective

Reduces the thermal signature of hot objects

Quiet, rustle free, and matt anti-reflective printing

Suitable for all climatic conditions from -40 °C to +70 °C. Remains pliable in extreme temperature ranges

Non toxic, lightweight, waterproof garnish

Excellent colour fastness to U.V, water and abrasion resistance

Made to UK MoD specifications

Strong, durable and extremely robust

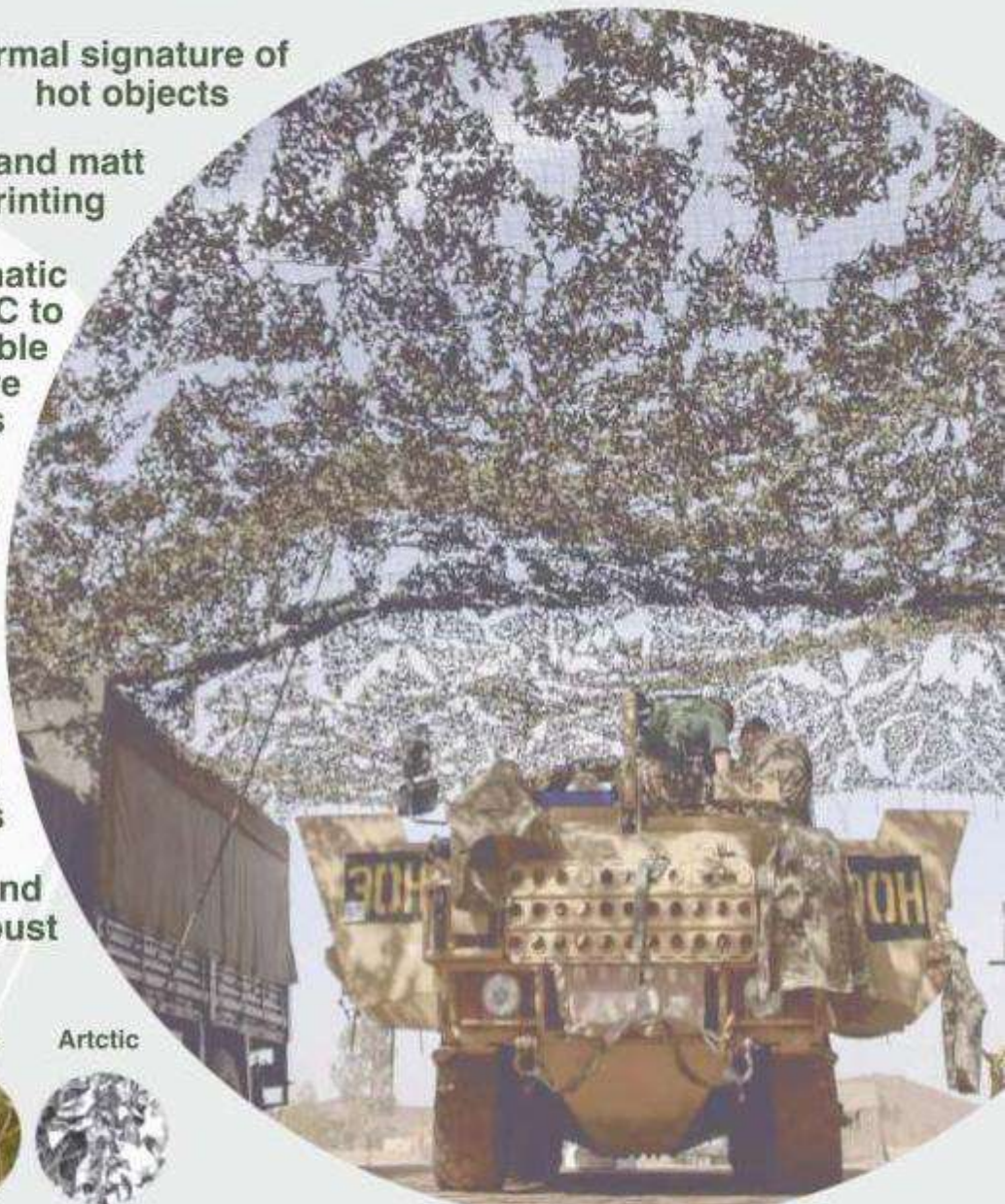

Woodland



Moorland/Mountain



Desert



Arctic



Size	Metres	Feet	Woodland	Moorland/Mountain	Desert	Arctic
2.4 x 2.1	8x7					
4.5 x 4.5	15x 5					
7.5 x 7.5	25x25					
9 x 9	30x30					
11 x 11	36x36					
11.5 x 5.5	38x18					
11.5 x 11.5	38x38					
12 x 6	40x20					
12 x 12	40x40					
14 x 12	46x40					
16 x 16	53x53					
18 x 18	60x60					

Our camo nets are tested to and exceed the following UK MoD specifications:
 UK/SC/5094 Issue 14
 UK/SC/4830
 BS 3900
 BS 1006: 1990
 BS 3424: 1982
 BS EN ISO 2286: 1994
 BS EN ISO 2286-2
 BS EN ISO 1421: 1998

Standard Set Includes:

- 4' Pole x 4
- 8' Pole x 4
- Adaptor Sleeve x 8
- Spreader x 6
- Bag x 1
- Ground Stakes/Pegs x 24



UK Made



Safetystyle's camouflage nets can be made to your requirements. They come in various sizes and colours in order to camouflage almost anything.

Used by British Army and many other NATO members in South America, Asia and Middle East

Shower resistant

Available in: Woodland, Desert, Mountain/Moorland, or Arctic. Patterns, colours and sizes can be customized according to customer requirements.

Perimeter edge cord

Loops in each corner, and down long sides

U.V treated, mould and rot resistant

Strong

Safetystyle has been supplying the lightest camouflage systems to the UK MoD and to the international market for many decades. Over this time, Safetystyle has built up a reputation as a market leader by delivering the best quality camouflaged goods on time and fit for purpose.

Additionally nets can be supplied in any size and may be joined together to cover larger and even awkward terrain. Light, synthetic materials are used in the manufacturing process for your convenience when transporting and handling our nets. Nets may be used in alternative environments for your commercial or personal interests, for example trade shows, museums, stage sets... the possibilities are endless.



NETS

INDIVIDUAL CAMOUFLAGE NET



Lightweight and easy to carry



Multispectral - protects the wearer in the **visual, infrared and thermal** spectrums.



Camouflage net blocks thermal energy transmitted by the soldier

Features a random pattern to allow the camouflage to blend in with the irregularities of nature

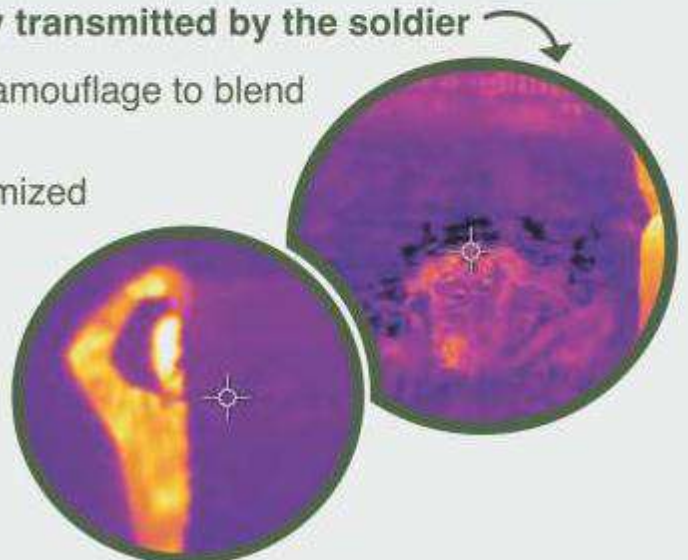

Patterns, colours and sizes can be customized according to customer requirements.

Code	Special Order - Please contact for more information
	1.33kg
	2x2 metres (6ft 6"x6ft 6")



SNIPER SUIT



- Constructed from a comfortable, bug-proof netting, which is hand-washable
- Made from durable lightweight polyester fabrics
- Rot and mould proof, fire resistant
- 3D leaf-like foliage
- Quiet and rustle-free
- Pre-made, no assembly required
- **Compactable and strong**
- **Reversible colour combinations for added concealment**
- Designed to **break up your outline, disrupt your landscape and disguise objects**
- **Non-toxic environmentally friendly**
- The system offered is a complete and ready to wear ghillie suit comprising of a hood, long jacket and trousers, all in 3D disruptive woodland camo netting

Code	RGKT01
	2.6kg (5.7lbs)
(Chest)	M/L 95-110cm (38-44")
	XL/XXL 115-130cm (46-52")



GHILLIE SUIT

- 4 pieces set - **hood, jacket, trousers and gun cover**
- **Elastic/drawstring** at waist, chest, neck and cuff
- **Easy snap closure** on jacket
- **Adjustable** chin strap in hood
- **Ultra lightweight**
- **Removable knee and elbow pads**

Code	RGKT01A
	1.39kg (3.06lbs)
(Chest)	M/L 105-120cm (42-48")
	XL/XXL 120-140cm (48-56")

Due to our continual product development, we reserve the right to alter or amend these products from what is shown, without prior notice.

SLEEP/SHELTER

SHELTER SHEET

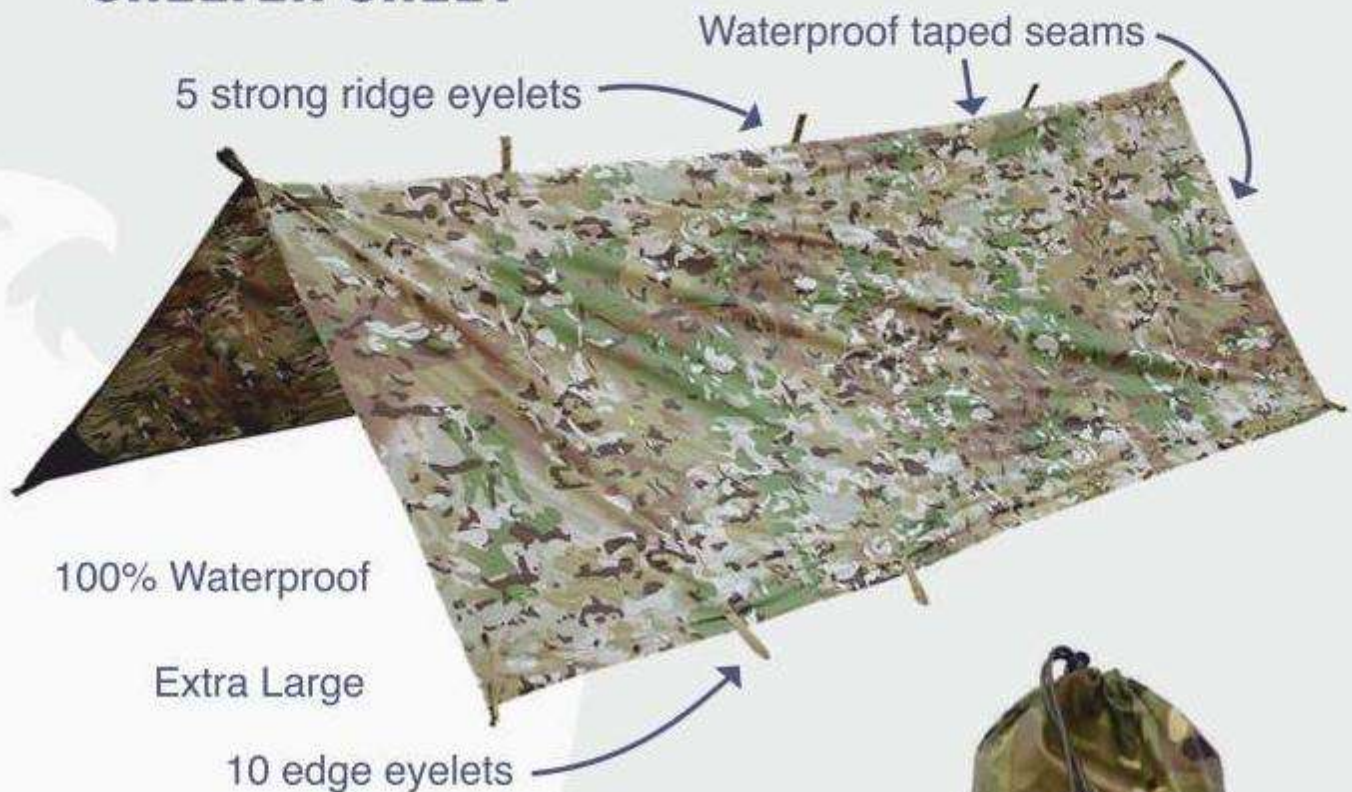

Can be slung between trees, tethered to vehicles, supported on bivouac poles, or folded double for use as a stretcher.

Multi Terrain Pattern (MTP)



Comes with a draw-cord closing system made of raided nylon, 9mm wide in light olive green.

Main material is silicone elastomer coated nylon.

Webbings are made of textile, nylon, single ply and the are 25mm & 55mm with a multi-terrain pattern. All ends are heat sealed.





Code	CT125
NATO	NSN 8105-99-213-3731
	2.6 metres x 2.16 metres (8.5 ft x 7 ft)

STEEL PEGS



10 Steel pegs for use with tents and bashas

Code	CT017
NATO	NSN 8415-99-213-3730
	260 grams (9.5oz)
	18cm (7")

FOX® LIGHTWEIGHT WATERPROOF 3 PART SLEEPING SYSTEM

1 COVER (BASHA)

A lightweight robust shelter sheet forming the third element of the fox sleeping system. Features a fully tape-seamed hem and reinforced, suspension points.

Code	CT047  CT047G 
	630 grams (22.2oz)
	257x214cm



Compact and lightweight PU coated Ripstop Nylon Woodland camo print
16 x suspension points
NATO approved
2 mosquito net suspension points

2 MOSQUITO NET



Fox® Jungle Mosquito Net

A rugged, close weave polyester mosquito net.

The net is clipped to fabric loops underneath the basha and via elasticated hooks underneath the hammock.





This shapes the net, pulling the mesh walls away from the body and prevents the net from sagging and allowing insects to enter.

Code	CT433 
	480 grams (16.9oz)
	225 x 120 x 105"cm (88 x 47 x 41")

3 HAMMOCK

Fox® Jungle Hammock

A generously sized, parachute grade, ripstop-nylon hammock.

Code	CT430 
	590 grams (20.8oz)
	270 x 140"cm (106 x 55")



Extremely hard wearing and comfortable it provides protection against the elements and biting insects.

Extremely strong.

*Measurements are approximate

Complete Fox System 3 in 1: **1 + 2 + 3**

The complete system includes hammock, mosquito

Code	CT434
	1.7kg (60oz)

SLEEPING

SELF INFLATING MAT



Extra thick foam makes it ideal for use on stoney terrain

Brass inflation valve. If required the mat's inflation can be topped up orally via the valve



Fastening straps supplied

Quick & easy to assemble

Top: pvc with a non slip taffeta coating
Base: pvc with a non-slip polyester coating

Load limit: 200kg maximum stuff bag
Top colour: dark green
Base colour: grey



Foam: polyurethane 24kg/m³

Code	CT650D
	1.39kg (3.06lb)
	Packed: 32 (H) x 19cm (W) Open: 190 (L) x 60 (W) x 2.5cm (H)

Mummy shaped

Materials (top): 210t diamond ripstop polyester coated pvc orange

Materials (base): dobby polyester coating pvc + foam

Code	CT649
	770 grams
	Inflated: 180x50x3CM (70.8x19.6x1.1") Packed: 16x26CM (6.2x10.2")

INFLATABLE AIRBED



FOLDING SLEEPING MAT

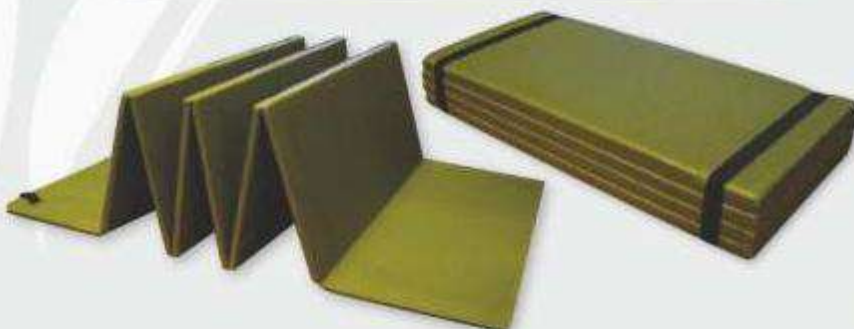



This new foldable sleeping mat fits inside your rucksack

Combines **durability** and **non absorbent** qualities as well as **insulation** and **compression resistant**

Can be used as a **sit mat** when folded

It can be used fully unfolded or in a **number of combinations**

Material complies with **UK military standard**

Code	CT650B
	350 grams
	Open: 52x180x0.8cm (20.5x70.9x0.3") Folded: 52x6x23cm (20.5x2.4x9")



MODULAR SLEEPING BAG SYSTEM



The modular sleeping system includes **two sleeping bags**:
 One for warmer climates (+12°C)
 One for temperate climates (-2°C - 6°C)

For cold weather, the two sleeping bags can be combined for additional warmth

100% Reinforced synthetic Rip Stop

Code	CT128
 Weight	3.2kg (7lbs)
 Dimensions	80 x 220cm (31.5 x 86")

OLIF RANGE SLEEPING BAG

Stays warm in -35°C



Code	Olif SZ: CT1210 Olif 35: CT1200
 Weight	2.4kg
 Dimensions	220cm x 75cm

The Olif is a top of the range sleeping bag designed to withstand extreme climates.

Ranging from -14°C to -35°C, the Olif is a must have to ensure adequate protection against the outdoors.

Both variants are also available in a bright orange colour.

	Olif Sub-Zero	Olif -35
Colour	Olive or Orange	Olive or Orange
Filling	300g/m ² synthetic micro-fibre	400g/m ² synthetic micro-fibre
Shape	Mummy shape with hood	Mummy shape with hood
Outer	70D Ripstop nylon	70D Ripstop nylon
Lining	40D Nylon	40D Nylon
Tested to:	EN ISO 23537-1:2016	EN ISO 23537-1:2016
Extreme	-24°C	-35°C
Low	-7°C	-14°C
Comfort	0°C	-7°C

MINI HAMMOCK

Extremely strong 2.5cm (1") mesh

Includes 2m (6ft) rope

Lightweight

Holds up to 120kg

Code	CT430C
 Weight	320 grams (11oz)
 Dimensions	270cm (106")



SLEEPING

FOLDING MATTRESS

Lightweight and space efficient

Capable of resisting excessive absorption of liquids

Comfortable when used in all climatic conditions



PU cover

Ease of packing with 5 folding sections

Hygienic and washable



Manufactured to ISO 9001/2008
Tested to conform to: BS7177:2008 + A1 2011
domestic use, BS EN 597-1: 1995
Resistance to ignition with source

Code	FF007
NATO	NSN- 7210-99-695-4361
	3.2kg (7.05 lbs)
	Packed: 64(L) x 33(W) x 31.5cm(H) Unpacked: 200(L) x 64(W) x 50cm(H)

X-LARGE FOLDING BED



Over 2 metres long



Extra strong **specially designed for large people**. The fabric is treated so that it won't stick or melt in hot temperatures, or make any noise when in use.

Stable on moderately uneven ground

Fabric: 100% **fire resistant** polyester
Frame: **Aluminium**, anti-oxidation
Frame thickness 1.4mm
Thickness 2.5mm
Weight bearing capacity 150KG
Carry bag material 600D polyester
Tested to conform to: EN 581-1: 2006,
EN 581-2: 2009

Code	FF006NL
NATO	NSN-7105-99-669-8141
	8.5kg (18.7 lbs)
	208 x 68 x 45CM

Current NATO issue bed

Strong and robust

Military approved and tested

Compatible with camp-cot mosquito net

Easy and quick to deploy

Cover 500D polyster material



Compact when folded

Manufactured to ISO 9001/2008

Tested to conform to: EN 581-1: 2006, EN 581-2: 2009

CAMP BED LIGHTWEIGHT



Code	FF006
NATO	NSN- 7105-99-669-8141
	7.5kg (16.5 lbs)
	Folded: 97cm(L)x18cm(W)x20cm(H) Unpacked:196cm(L)x76cm(W)x44cm(H)

CAMP COT MOSQUITO NET

Net top can hang a torch, book storage bag and other personal items

2 x long 9 section elasticated strong poles manufactured to ISO 9001/2008

75D nylon fabric, 21g/m 156 hole/inch

A compact robust close weave polyester mosquito net

Easy and quiet open double zips

Supported by two aluminium poles, which create a dome effect to ensure the mesh is pulled away from the body and prevents the net from sagging

Products material all match WHO standard

Permethrin impregnated

Easy setup - about 8 minutes

Fixes onto camp cot folding bed

Noiseless material

Waterproof ground sheet

Two door (side entry)

Code	FF008
NATO	NSN-7210-99-731-1754
	220cm (L) x 80cm (W) x 110cm (H) (86.6 x 31.5 x 43.3")



FOUR SEASONS TENT - 6 PERSON

The Safetystyle Four Seasons is an **ultra reliable, feature packed freestanding tent** capable of four-season use while backpacking, training and travelling

6 person

The four pole construction makes it **stable in high winds** and easy to pitch on uneven terrain.

Includes **extra pole** segment for repairs

20 pegs included

4 strong aluminium poles for easy set up



Available in a range of colours subject to MOQ

Wide strong snow skirt

60 cm valance for use in different conditions

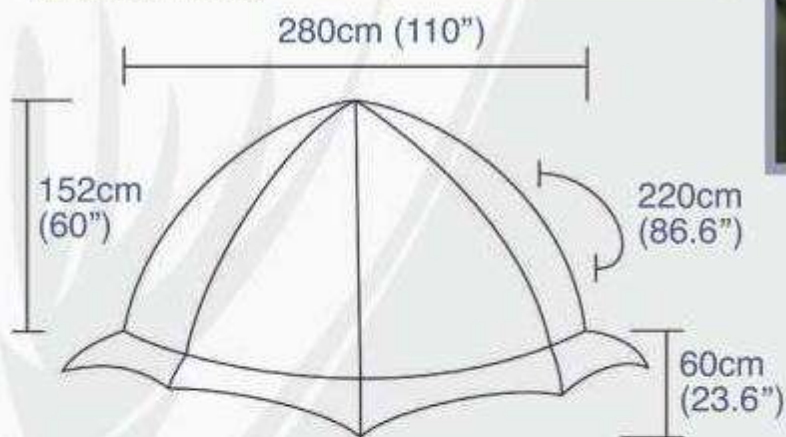
Ventilation holes



Code	CT670G
	7.5kg (16.5lbs)
	Packed: 68x27x23cm (26x10x9")
	Open: 280(W) x 220(D) x 152cm(H) (110" x 86.6" x 60")



INFLATABLE PILLOW

This handy travel pillow packs up **small and is quick to inflate.**

Made of PVC covered with **comfortable Swedish polyester.**

The bottom is **anti-slip** polyester.



Code	CB601
	60 grams (2.1oz)
	32x22x10cm

P.O.G - PROTECTIVE OVER GARMENT



The original protective over garment just got better

The Safetystyle strap provides as much **comfort** as possible whilst providing **high level ballistic protection to the groin and posterior.**

The front portion is designed with a clip to enable the wearer to easily urinate, without having to doff or unravel the garment.

This feature seems like a small benefit, but it is amplified during an operation.

- **Comfortable**
- **Fully adjustable**
- **NIJ Level IIIA Jock –Strap design**
- Front can be worn separate to the rear section
- **Easy to don and doff**
- Cupped shape to the front provides **space and airflow**
- Overall weight of just **970 grams**. Front portion weighing just 480 grams
- Rear attaches with one clip at the front and two G-Hook at the sides
- Each size is **adjustable to fit various shapes and sizes**
- Rear attachment **elasticated** to conform to the wearer's movements in use
- Rear can be **folded and stowed** on the back of the wearer
- **Robust and abrasion resistant** 500 denier Nylon carrier and Nylon webbing
- Designed to be worn over combat trousers
- Groin section is **soft and flexible** for comfort



Code	CB487
	970 grams (34.2oz)

BODY ARMOUR

THE KASTELL PRO®

POLICE/SWAT QUICK RELEASE PLATE CARRIER



This modular armour plate carrier vest is equipped with an **integrated quick release system** which works in less than **five seconds** and can be **re-assembled in less than 20 seconds**.

Designed to receive additional **protectors to the neck, shoulders, groin and coccyx** depending on the threat you are faced with.



With transport bag



Features:

- Weight without plates and soft armour inserts: 3kg
- D rings for attaching rifle slings.
- One size fits all. Height and width adjustment points on the shoulder and waist areas to fit all body sizes.
- MOLLE webbing on all faces of the plate carrier.
- Removable velcro ID badges.
- Designed for maximize comfort and to facilitate air circulation.
- Extra thick shoulders padding for greater comfort during prolonged patrols/missions.
- Fitted with a quad quick release system ideal when emergency medical treatment and tactical extraction are required.
- The quick release handle's are easy for right handed or left handed use.
- Can be worn while driving a vehicle.
- Does not restrict the firing position.
- Radio cables and hydration tubes can be threaded through.
- A strong evacuation handle.
- Back armour plate pocket can be moved up or down.

Code	CL425
	3kg

THE KASTELL PRO AQUA®



Waterproof interior liner on front and back.

550 Decitex (500 denier)



Extra padding to maximize comfort

Comfort spacer pads on the inside to maximize air flow and moisture management



- Made from FR and **quick drying fabric**
- Weight = 3.28kg (inc belt, groin and coccyx protectors)
- Designed to receive NATO standard 'stand alone'.
- Level IV armour plates.
- **One size fits most.**
- **Easy to adjust.**
- Equipped with quad **quick release system** which can be activated in **5 seconds** and clipped **back together in 20 seconds**. Release system is in service with US Army.
- Two grab handles on the back for a **quick emergency extraction**.
- Cable management on right and left sides (including shoulders).
- Laser cut **MOLLE** finish.
- Can be supplied with removable level IIIA soft armour

Quick release system:



Vented pads:



SEMI RIDGE PANEL



A high performance, lightweight and ultra-thin panel designed to provide discrete protection against hand guns, knives and explosions. Rated to NIJ Level IIIA 0108.01 (Ballistic resistant protective materials) which includes 44 magnum, 9mm and all lesser threats. Constructed from advanced proprietary technology and is available curved or flat. Dimensions 25 x 30cm (10 x 12") weighs 0.96lb (440 grams). Less 5mm thick (3/16 inch).

Can be used in a variety of different applications including backpacks, clipboards, briefcases, handbags, trauma armour, structural armour, upgrade plates etc.

Code	CL425
	With extras*: 3.28kg (7.2lbs) Without extras: 2.16kg (4.7lbs)

* Extras = Belt, groin and coccyx protectors

ICW



Multi curve design for improved comfort and ergonomics. Must be used with NIJ IIIA soft armour.

Available in five different configurations;
1/ NIJ IV ICW
a/ 2.45KG plate.
b/ 2.1KG plate.
2/ NIJ III ICW
a/ 1.95KG plate.
b/ 1.7KG plate.
c/ 1.25KG plate (inherently buoyant)

BODY ARMOUR

MICH WITH RAILS



A reduced weight, higher cut at the back and sides and removal of the front peak. This new low profile provides excellent compatibility with communications equipment, gas masks and especially helmet mounted night vision goggles. The helmet is constructed from para aramid material and provides lightweight, robust protection from ballistic and fragmentation projectiles and other low energy threats. Protection against fragments from V50 450m/sec V50650m/sec according to STANAG 2920 (17gr FSP) and US MIL STD 662F. Ballistic protection is NIJ IIIA.

Code	CL532
	1.4kg (3lbs)
	NIJ IIIA

Produced using high tenacity Kevlar aramid material Crown Mesh Internal Suspension System for improved airflow and stand off from head with 4 point adjustable harness system.

Large neck support nape pad for improved comfort and helmet

stability. Accessory side rails for attachment of equipment. Front

facing shroud for attachment of night vision goggles.

Fragmentation Protection V50 640 m/s against 1.1g FSP in accordance with STANAG2920

Shock absorption to EN397 Standard

TACTICAL SPECIAL FORCES





Code	CL062
	NIJ IIIA

COVERT





This concealed undershirt is a side opening vest with adjustable shoulder closures. It has pockets for Trauma and Hard armour plates and can withstand multiple hits. It is easy to maintain having removable and machine washable covers. Standard colours are: white, black, navy blue and beige. Other colours are available on request.

Code	CL216
	2.5kg (5.5lbs)
	NIJ IIIA

- Unmatched protection
- No sacrificing comfort
- Keeps you in total control of any situation.

Already protecting many people around the world, it can be customised to meet your needs with additional armour coverage, MOLLE pouches, Velcro patches etc.

Code	CL533
	3kg (6.6lbs)
	NIJ IIIA

OVERT



The most complete protection available.

Combining our commitment to **comfort and versatility** with **extreme protection**, this vest is available in the highest NIJ Levels to guarantee you unsurpassed safety.

Complete with front, back and side panels, neck, throat, groin and upper arm protection.

This armour remains **flexible and as light as possible**.

Also includes MOLLE™ webbing for extreme flexibility and comfort.



Code	CL198
	NIJ IIIA

MAX PROTECT

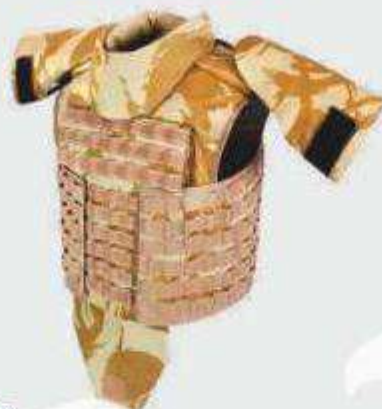

BALLISTIC BLANKET

Designed to provide a portable, flexible, lightweight, compact and multi-purpose means of ballistic protection. It has a number of loops around its perimeter, enabling it to be hung from objects, such as fences, when protection is required.

Magnets mean that it can also be rested against cars, vans

and other metal objects. It can be folded for storage and has handles for ease of transportation and deployment.

Other sizes are available on request.

Code	CL534
	125 x 125cm (49.2 x 49.2")
	NIJ IIIA

A breathable, comfortable, thin layer of clothing that will protect you from the threat of a blade edge and sharp cuts. This vest offers protection whilst remaining concealed. The material is lightweight, comfortable and breathable without compromising cut and slash protection.

Concealable- wear alone or under a shirt.

Comfortable, breathable and lightweight knit

Soft, cotton-reinforced neck, arm and wrists.

Choose sleeveless or long sleeve.

Suitable For:

- Security Personnel
- Club Security
- Law Enforcement and Prison

Code	CL064 (Sleeve)
	CL063 (Sleeveless)
	NIJ IIIA



STAB SHIRT



ARMOUR PROTECTION LEVELS

NIJ IIIA	ICW NIJ III	ICW NIJ IV	NIJ IV
Hand Guns 9mm, .44	5.56, 7.62 (NATO)		Armour Piercing 7.62 AP
Semi Rigid Panel (<1kg) Or Soft Armour (3kg)	ICW Plate and Soft Armour (>5.5kg)	ICW Plate with Soft Armour (>7.2kg)	ICW Plate with Soft Armour or Stand Alone Plate (>6.1kg)

VEST CUSTOMISATION

At Safetystyle we want the solution to best fit the requirement and balance this with your available budget. To achieve this, we offer the option to customise and build a bespoke product just for you.

This can involve simple changes in features and functions e.g. one of both side openings, to different colours and patterns, or adding improvements such as a quick release system.

Call or email us to discuss your requirements, should the above standard options not be exactly what you are after.

GLOVES

ALL GLOVES ARE AVAILABLE IN MULTIPLE STANDARD SIZES

- **Supple high quality water, heat and oil resistant goatskin outer**

- Comfortable 3 dimensional aramid composite lining

- Suede leather palm reinforcement

- **High impact-resistant foam padding** to back of hand, fingers and wrist to protect against trauma hazards

- Sewn with fire-resistant thread

- **Fully waterproof, breathable microporous membrane** providing additional limited protection against:

- Petrol, certain acids and other chemical risks

- Blood-borne pathogens (ASTM 1671)

- Available in sizes: 6-13

Code CB295

PUBLIC ORDER GLOVES



COMBAT GLOVE



- This Lightweight Glove is designed with comfort and functionality in mind

- The glove offers **premium flexibility, feel and protection**

- Reinforced **carbon fibre** knuckle and hand protection design

- High grade aniline goatskin leather

- The mid-height soft cuff does not restrict movement

- Velcro fastening strip

- Breathable sides to fingers

- Available in **Tan** and **Black**

Code CB215 ●
CB214 ●

- An extremely lightweight (15 gram, 0.5oz) tactical glove that offers cut and burn resistance without compromising tactile abilities.

- Heat resistant - ideal for stripping a hot GPMG or working with vehicles in a hot environment

- Cut-resistance

- Puncture-resistance

- Tight fitting

- Silicone printing gives excellent non-slip grip

- Can operate touch screens

Code CB216

- Excellent tactility

HOT WEATHER GLOVES



COBRA GLOVE



- Cobra features an unlined trigger finger for optimum weapons handling
- Ideally suited to training and operations where simultaneous operation of firearms is required
- This glove offers **high levels of protection** combined with **durability and dexterity**
- Specially formulated **waterproof and abrasion-resistant coated Kevlar® fabric outer**
 - Double layer on palm
 - **Fire-resistant** Nomex® III lining
 - **Unlined leather trigger finger**
 - EN388: 1994 4.3.4.4 Certified
 - Available in sizes: 7-12

Code	RGKI31 RGKI31A (Roping option)
-------------	-----------------------------------

MITTENS



- A performance mitten offering excellent warmth and a supple synthetic palm for added dexterity and feel
- 100% Waterproof, Windproof & Breathable
- Soft and durable synthetic palm for grip and easy washing
- PU suede wiper on thumb for a multitude of uses
- Size Options - S, M, L, XL, XXL

Code	MC13
-------------	------

LIGHTWEIGHT TACTICAL GLOVES



- Camouflage print lightweight tactical gloves
- Integrated breathability to keep hands dry and comfortable
- Elasticated cuffs for secure fit
- Fingertip design reduces wear over time

Code	CB259
-------------	-------

BASE LAYERS

MADE FROM MERINO WOOL, SAFETYSTYLE'S BASE CLOTHING IS OF THE HIGHEST QUALITY AVAILABLE

BASE LAYER TOP



Our base layers are made from 100% natural Merino wool, helping your garment stay fresh and odour-free, actively wicking away moisture from the skin – keeping you dry and comfortable.

These garments also provide extra comfort and warmth, due to the soft and tightly-knit material

Code	MC02 (Top) MC01 (Long Johns)
	S, M, L, XL, XXL

THERMAL SOCKS



Thermal Liner Socks have a high wool content for comfort and warmth.

They can be worn as a liner or as an everyday sock.

Code	MC04D
	25 grams (0.9oz)

BASE LAYER LONG JOHNS



**100%
NATURAL
MERINO
WOOL**



LINER GLOVE



**Extra
Comfort**

Close fitting inner gloves in fine Merino wool for increased comfort

Ideally worn under our range of waterproof gloves to give added insulation.

Extra comfort and moisture control – High Merino Wool content.

Added warmth and protection from full finger design

Breathability – Fabric wicks sweat away

One Size

Code	MC08
	150 grams (5.3oz)



Scarf



Balaclava



Hat



Headband

HEADOVER



**Multiple
ways to
wear**

Code	MC135
	150 grams (5.3oz)

- Elastic - **maintains its original shape**
- Made from 130g/m **Merino wool**
- Available in black
- One size fits all**

The Headover is a **very versatile garment**. It can be used as a **scarf, headband, balaclava or hat**.

FOOTWEAR

PANTHER 8.0

- Padded collar for comfort
- Fast wicking lining for moisture management & comfort
- Durable leather upper with hardwearing breathable mesh
- Durable rustproof hardware
- EVA insole for shock absorption & comfort
- High traction rubber outsole designed for maximum grip

Code	(No zip)	(Zip)
	CC048	CC048A
	710g* (25oz)	590g (20.8oz)



STRIKE FORCE 8.0

High traction rubber outsole designed for maximum grip

Padded collar for comfort

Fast wicking lining for moisture management & comfort

Armourgel ultimate ankle impact protection

Durable leather upper with hardwearing breathable mesh panels

Scanner safe non-metallic composite hardware

Compression molded RECOIL midsole absorbs impact and provides all-day support and comfort

M-P.A.C.T Response insole for maximum comfort & shock absorption



Code	CC071
	620g* (21.8oz)

VIPER PRO 5.0

Padded collar and tongue for comfort

Ankle pads for added protection

Durable leather upper with hardwearing breathable mesh panels

EVA midsole for underfoot comfort



Scanner safe, non-metallic composite

Fast wicking lining for moisture

Waterproof & breathable boot membrane keeps feet dry

M-P.A.C.T Response insole for maximum comfort & shock absorption

High traction rubber outsole designed for maximum grip



Code	CC247
	530g* (18.6oz)

*Based on 1/2 pair US 9/EU 42/UK 8

HERA MONSTER

Breathable suede leather

Primer: * Gore-tex membrane

Highly breathable

Durable and 100% waterproof

Double density polyurethane / rubber sole technology

Antistatic and oil resistant

Shock absorption and softness provides comfort

Provides superior mobility and stability

Anatomically shaped, washable, shock absorbing outer



Code	CC072
------	-------

FOOTWEAR

MONSTER DESERT BOOT



Zipper

Breathable suede leather, woven polyamide 6.6 (Cordura®) textile panels with interlocking knitting system

Inner Lining: 65% Polyester

Dry-Touch® absorbs perspiration and dries quickly

Sole Technology: Double density polyurethane / rubber

Shock absorption and softness provides the most comfort

Engineered base design provides superior mobility and stability when climbing or overcoming obstacles

Reinforced thermoplastic dome

Code CC073

Highly breathable genuine nubuck leather

Zipper

Injection base technology; shock absorption and softness provide the user with optimal comfort

Water repellent Cordura textile panels knitted with locked knitting system

Rubber outsole resistant to abrasion and slip

Provides superior mobility and stability when climbing or crossing obstacles in terrain

Code CC074

MNTP TACTICAL BOOT



FIRST AID KITS

A useful multicam pouch with zip closure that reveals a number of pouches when opened. Contains a variety of first aid products suitable for the treatment of minor injuries



MILITARY F.A.K

- Tweezers • Antiseptic Wipes • Waterproof Plasters • Wound Close Strip • Resuscitator With One Way Valve
- Various Dressings • Paratulle • Triangular Bandage
- Crepe Bandage • Anchor Dressing • Conforming Bandage • Disposable Gloves • Safety Pins • Scissors
- Plaster Strip • Microporous Adhesive Tape • Zinc Oxide Tape • Razor Blades • Pouch

46
Items

Code	CS113M
	430g (15oz)
	Closed: 18x12x9cm (7x4.7X3.5") Open: 38x12x4.5Cm (15x4.7X1.7")



A handy pocket sized pouch with belt tunnel loop, containing basic medical kit. Excellent for hikers who want to travel fast and light.



PERSONAL FIRST AID KIT

- Antiseptic Wipes
- 10 X Adhesive Dressings
- Medium Wound Dressing
- Triangular Bandage
- Set Of Safety Pins
- Accident Evaluation Report
- Instruction Leaflet
- Pouch

Code	CS476 CS476M
	65 grams
	10x17.5x4.5cm (3.9x6.9x1.8")

22
Items







LIFESAVER 1

30
Items



- Bandages
- Dressings
- Plasters
- Antiseptic Wipes
- Scissors
- Safety Pins
- Instructions

Code	CS111
	138 grams (4.9oz)
	14x13x4cm (5.6x5.1x1.6")

The Lifesaver #1 is a large pocket size kit for day trips

- antiseptic wipes x 2
- adhesive dressings x 10
- suture plaster
- medium wound dressing
- paraffin gauze burn dressing
- triangular bandage
- knuckle „h” shaped bandage
- white open weave bandage
- medical gloves (pair)
- set of safety pins
- scissors
- accident evaluation report
- crepe bandage
- instruction leaflet
- lifesaver pouch



LIFESAVER 2

35
Items



Code	CS110
	320 grams (11.3oz)
	23x19x5cm (9.1x7.5x2")

The Lifesaver #2 intermediate kit is for longer journeys and larger groups of people.

- antiseptic wipes x5
- adhesive dressings x10
- suture plaster
- medium wound dressing
- paraffin gauze burn dressing
- weave bandage
- medical gloves (pair)
- set of safety pins
- scissors
- microporous adhesive tape
- accident evaluation report
- hospiform bandage
- instruction leaflet
- isotonic drink
- lifesaver pouch
- anchor dressings
- conforming bandage

MEDICAL

A life-saving product for all dismounted soldiers

The personal stretcher is **easily and securely fastened by Molle** to the back of the soldier's body armour, from which it can be opened in a **matter of seconds**

The stretcher enables an injured soldier to be **quickly carried to safety** and receive medical attention

Made from lightweight and robust fabrics

Packs flat and fits between the body armour and the daysack

Features:

Six long grab handles for **easy transportation**

Available in **all camouflage patterns**

Made from **robust rip stop nylon** and **high tensile strength nylon webbing**



IRR treated

CARRY SHEET



Carry Bag Included



Code	CT100
	280g (10oz)
	Closed: 28x24x1.8cm (11x9.4x0.7") Open: 190x75cm (74.8x29.5")

Secure for the casualty - the stretcher is attached to their body armour

MICRO STRETCHER



The Micro-Stretcher is a lightweight, compact yet rigid stretcher

For rough terrain or where there may be limited access.

Quick to deploy

Compact

Can be utilised as part of a back-pack



Code	MF451
	Packed: 5.1kg Unpacked: 4.6kg
	Closed: 28 x 24 x 1.8cm (11 x 9.4 x 0.7") Open: 190 x 75cm (74.8 x 29.5")

CLIMBING/MARINE BASKET STRETCHER





Extra
Secure

A rigid basket stretcher with multiple hand holes, lifting points & foot plate.

For hand, rope and helicopter rescue.

- Suitable for a wide range of situations.
- Strong polyethylene and aluminium structure
- Adjustable lifting bridles available
- Complete with patient restraint straps
- Moulded runners and handholds

Code	MF400A
	Weight: 13.5 kg (29.7lbs) Capacity: 278 kg (612.8lbs)
	217 x 62 x 18.5cm (85.4 x 24.4 x 7.2")

MEDICAL

FOLDING STRETCHER

The folding stretcher is a duo-fold design, allowing a normally bulky item to require minimum storage space when not in use

- The aluminium frame, is both **strong yet lightweight**
- Stretcher bed is **resistant to fluid and is extremely easy to clean**
- Once locked open, the **frame keeps the patient clear of the ground**
- **High strength aluminium** alloy frame
- **Waterproof, fireproof, anti-cracking material**
- Hi-Vis orange or olive
- **Easy to clean**

Minimal
Storage
Space

Folds both horizontally and vertically:

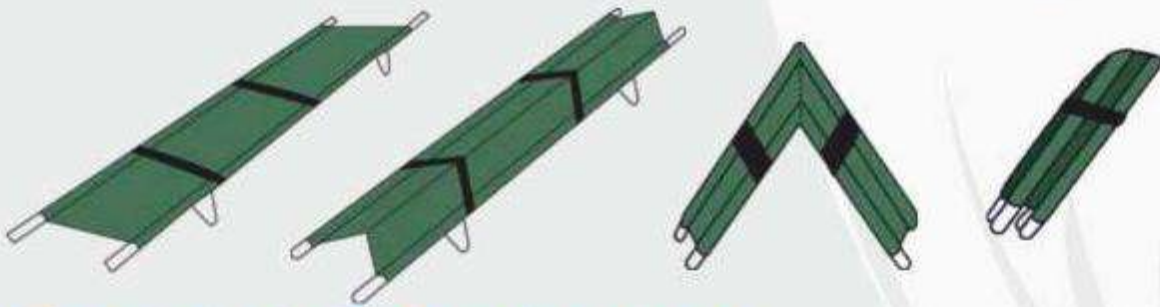

- Complete with **fully zipped carry bag and straps**
- Very strong: can carry **up to 159kg (350lbs)**

Frame
keeps
patient
off
ground



Code	MF446
	5.4kg (12.1lbs)
	Open: 14x52x206cm (5.5x20.4x81.1")
	Folded: 10x18x103cm (3.9x7x40.5")



Opening the sealed packaging lets oxygen react with the bag. Within a minute they release constant heat

Typically these packs are used for comfort, increasingly however, they are used in rescue operations where a survivor is trapped in a cold or exposed place

40 per box

Max temperature: 50 °C to 65 °C

Duration: 20 hours

Code	40 pack: CL280
	572g (20oz)
	13x9cm (5x3.5")

up to
20 hrs
of heat

BODY WARMERS

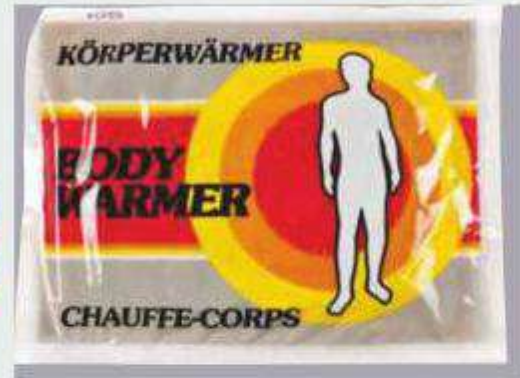

HAND WARMERS (X2)



Hand warmers work within a minute to instantly warm hands when necessary.

40 pairs per box

Max temperature:
57 °C to 70 °C

Duration: 7 hours

Code	40 pack: CL281
	25g (0.8oz)
	8cmx2cm (3"x1")

KNIVES

Egress through the Plexiglas of a chopper. Plus, the LMF II does a slick job cutting firewood and building shelter.

Features:

- 2 Leg Straps
- Sheath
- MOLLE Compatible

Code	CM0134
	(w/ Sheath): 688g (24oz) (w/o Sheath): 330.8g (11oz)
	26.8cm (10.59") Blade: 12.3cm (4.84")

LMF II INFANTRY FIXED BLADE KNIFE

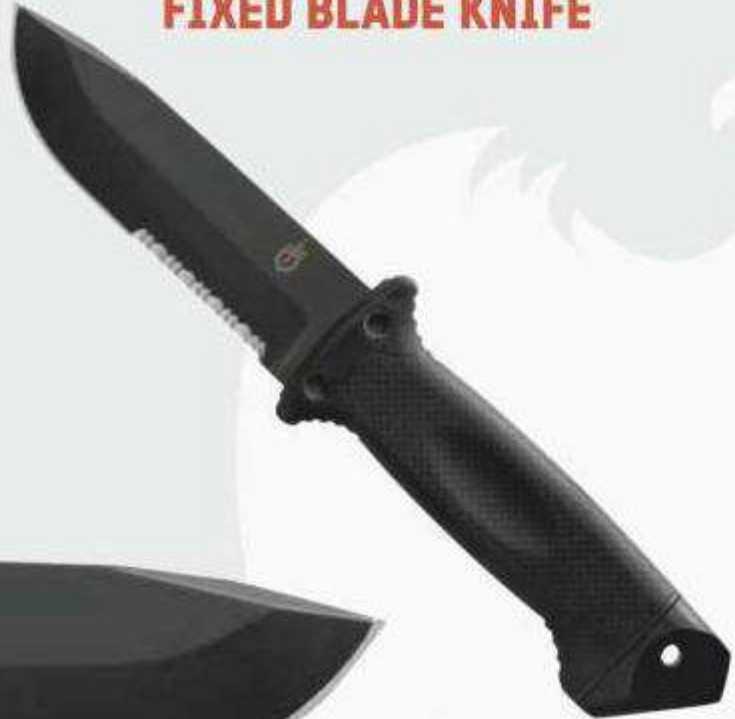

Restricted sale item

DMF MANUAL KNIFE

Semi-Serrated Tactical Blade
With Modified Clip Point

Ambidexter Trous
Wedge Lock

Thumbstud for One-Hand Opening

Lanyard Ring





Restricted sale item

A small, handy and sharp knife with several features, as seen above.

Easy to transport and can be opened with one hand

Dual thumb studs enable it to be opened neatly, with the blade "snicking" open, where it is held securely by a wedge lock - a simple ambidextrous slide release.

Code	CM902
	737g (25.9oz)
	21cm (8.2") Blade: 9cm (3.5") Closed: 12cm (4.7")

GATOR JR.



Restricted sale item

A short, tough, easily packable machete

The two-sided blade has both a fine edge for hacking through the jungle and a serrated edge for rough-cutting

Low-profile, its the perfect lightweight machete

Tactile rubber grip

Fine edge and saw blade

Riveted, nylon sheath included

Head: high carbon steel

Handle: gator-grip

Code	CM0135
	405g (14.30oz)
	47.6cm (18.75") Blade: 27cm (10.75")

Has a 15-inch fine-edge blade on one side and an 18-inch high performance saw blade on the other

Tactile rubber grip

Forged of high-carbon stainless steel

Code	CM135
	510cm (18oz)
	65cm (25.7") Blade: 45.7cm (18")

GATOR MACHETE



Restricted Sale Item



Riveted, nylon sheath included

Fine edge and saw blade

Handle: Gator-Grip
Head: High Carbon Steel

FREESCAPE CAMP SAW



Code	CM116
	433 grams
	Overall: 37.3x16.7x2.8cm (14.6x6.5x1.1") Closed: 35x4.5x2.8cm (13.7x1.7x1.1") Blade: 30.5cm (12")

Robust folding saw

Perfect for travelling and camping

SHOVELS/SAWS

"A high quality shovel, lightweight and extremely strong. It is the premium size and weight. It has an extremely robust composition which could withstand excessive damage." - Military trial report

When tested to destruction this shovel could not be broken

Blade - Made from hardened boron steel

Shaft - Drop profile cold formed welded precision tube

Code	CM0077
	1.6 kgs (3.5lbs)
	94cm (37.6")

GENERAL PURPOSE SHOVEL



GORGE FOLDING SHOVEL



The Gorge is lightweight and packable for back-country camping and hiking.

Nylon draw string bag included.

Easy-to-use push button slide mechanism

Hammer feature at base, great for hammering tent stakes



Nylon drawstring bag for easy transport

Small, compact size

Glass-filled Nylon Handle

Pick designed for use on hard packed ground

Sheath: Nylon bag



Code	CM0064
	794g (28.0 oz)
	41.9 cm (16.50") (Closed) 23.5 cm (9.25")

This shovel is perfect for clearing snow. It is robust and compact enough to carry around.

Strong, yet lightweight material.

Handle slides down to make storage easier.



Code	CM157
	476 grams (16.8oz)
	Folded: 45x22.5cm (17.7x8.9") Open: 65x22.5cm (25.6x8.9")

TELESCOPIC SNOW SHOVEL



EXPLORER BUTTON COMPASS



An exceptionally robust, oil filled, pressurised military approved compass which features in most of our survival kits

Designed for escape and evasion

Load tested to 24kg
(52.9 lbs)



Code	CK311
NATO	NSN-6605-99-127-9239
	2g (0.07oz)
	1.3cm (0.51")

The full-size base plate compass for experienced navigators.

The Expedition 4 is used by many defence forces around the world

Compass housing made from Dryflex™ - rounded base plate

Patented red/black orienting lines

Luminous markings - enables night navigation

Hole for marking positions on map

Built in magnifier for detailed map reading

Code	CK406
	74 grams (2.6oz)
	23.4x11.4x2.4cm (9.2x4.5x0.9")

EXPEDITION 4 COMPASS



3 IN 1 KARABINER, COMPASS + THERMOMETER



Metal case

Zinc alloy

Liquid filled with luminous dial for easy reading at night

Please note: Not to be used for climbing

Code	CK310
	30 grams (1.05oz)
	7x3x1.5cm (2.7x1.1x0.5")

Mils and degrees

A highly useful and resourceful compass for artillery, target acquisition and command posts.

Once activated by daylight/flashlight it will give up to 4 hours of light.

6400 mils on the graduation ring and 6400 mils + 360 degrees on the sighting scale.

Accuracy: $\pm 0.5^\circ$ (8.9 mils)

Altitude use: 5000m @ -15 °C

Waterproof

Code	CK401
	9 grams (0.3oz)
	126 x 60 x 16 mm

SILVA PRISMATIC COMPASS 55

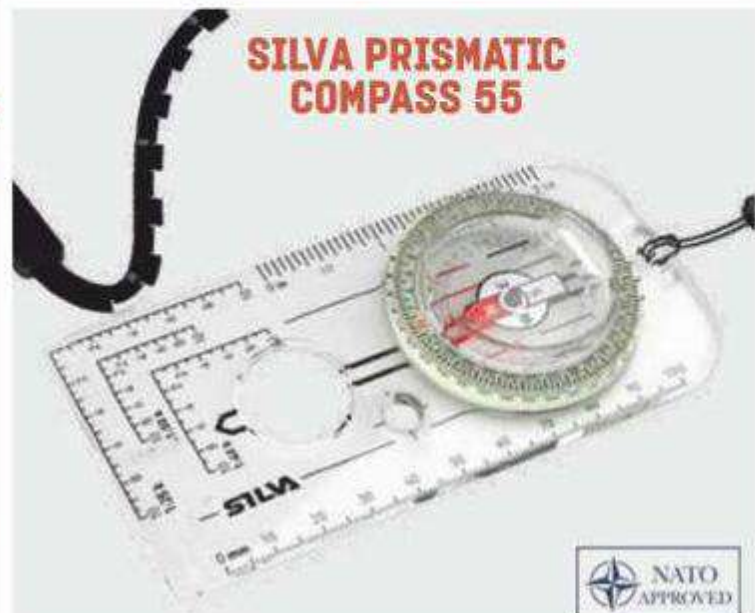

LIGHTING

High, low and strobe modes

Adjustable beam - wide or focused

Light source cree LED light chip

Slide focusing head patented slide function

Over **100 metres beam distance**

High grade aluminum alloy body

End cap switch easy access recessed rear mount power button

Removeable pocket clip

Rubberised tooth guard

Waterproof

Lumens: **130**

Runtime: **5 hours**

Batteries: **1 x AA** (battery not included)

Code	CE024
	53.8 grams (1.8oz)
	10.5cm (4") adjustable to 11.7cm (4.6")

COMBAT ZOOM FLASHLIGHT



LIGHT STICKS X 2



Excellent for map reading and in emergencies

Long lasting - up to 12 hours

Next to no storage space

Red, white or green (other colours available)

Code	CE570(R●/W○/G●)
	64g (2.25oz)
	11.2cm (4.4")

Durable and adjustable

Beam spot to flood capability, and bright CREE technology.

This dependable **180 lumen** light has **three modes** and offers no dead spots in the beam to give the user a **clear consistent beam**.

- Pull zoom for flood to spot operation
- 3 Modes: High, Low, Strobe
- CREE Bulb Technology
- Batteries included (3x AAA)

Code	ADV003
	72g (2.25oz)

HOT SHOT MINI HEADTORCH



ADVANCE PROGRESS FIREFIGHTER JACKET

We have developed the S GARD ADVANCE PROGRESS series for firefighting operations, in particular for interior operations with breathing apparatus. This protective firefighter clothing is especially lightweight, which means the firefighter jacket and trousers provide you with the best protection against heat stress. This turnout gear also comes with all the important details.



Product details

Outershell type 813:

DuPont™ Nomex® Tough, 195 g/m²,
75 % DuPont™ Nomex®, 23 % DuPont™
Kevlar®, 2 % P140 antistatic,
with FC finish

Moisture barrier/insulation:
GORE-TEX® FIREBLOCKER

Color:
Black Blue

Norms:

EN 469:2005 Level 2
EN 1149-5
ITC System

Available sizes:

XS – 3XL
Short sizes: KXS – KXXL
Long sizes: LS – LXXL



ADVANCE PROGRESS FIREFIGHTER TROUSERS

We have developed the S GARD ADVANCE PROGRESS series for firefighting operations, in particular for interior operations with breathing apparatus. This protective firefighter clothing is especially lightweight, which means the firefighter trousers and jacket provide you with the best protection against heat stress. This turnout gear also comes with all the important details.

Product details

Outershell type 813:

DuPont™ Nomex® Tough, 195 g/m²,
75 % DuPont™ Nomex®, 23 %
DuPont™ Kevlar®, 2 % P140 antistatic,
with FC finish

Moisture barrier/insulation:
GORE-TEX® FIREBLOCKER

Color:
Black Blue

Norms:

EN 469:2005 Level 2
EN 1149-5

Available sizes:

XS – 3XL
Short sizes: KXS – KXXL
Long sizes: LS – LXXL

ULTIMATE PARALLON™ SYSTEM FIREFIGHTER JACKET

We have developed the S GARD ULTIMATE GORE® PARALLON™ firefighter turnout jacket and trousers specially for firefighting operations and interior operations with breathing apparatus. This high-end firefighter clothing features maximum functionality and is made from high performance materials. It is ideally insulated and offers you a much freedom of movement.

Nearly all the spacious, close-fitting pockets have an angled design for optimum accessibility. They keep all the items you need safe and sound. And you can easily make all adjustments to the ULTIMATE firefighter jacket even when wearing gloves.



Product details

Outershell type 820:

Titan 1220 with Hainsworth® Technology, 220 g/m², 89 % DuPont™ Nomex®, 9 % DuPont™ Kevlar®, 2 % P140 antistatic, with Repel+ finish

Moisture barrier/insulation:

GORE-TEX® PARALLON™ System

Norms:

EN 469:2005 Level 2
EN 1149-5

Color:

Gold/ Black Blue

Available sizes:

XS – 3XL
Short sizes: KXS – KXXL
Long sizes: LS – LXXL

Preparation for IRS system:

Stowaway pocket system (DTS)

Stowaway pocket and casing

Note: Always order the DTS-compatible IRS system (Integrated Rescue Loop and Strap) separately



PARALLON™ SYSTEM FIREFIGHTER TROUSERS

We have developed the S GARD ULTIMATE GORE® PARALLON™ firefighter turnout jacket and trousers specially for firefighting operations and interior operations with breathing apparatus. This high-end firefighter clothing features maximum functionality and is made from high performance materials. It is ideally insulated and offers you a much freedom of movement.

Nearly all the spacious, close-fitting pockets have an angled design for optimum accessibility. They keep all the items you need safe and sound. And you can easily make all adjustments to the ULTIMATE firefighter trousers even when wearing gloves.

Product details

Outershell type 820:

Titan 1220 with Hainsworth® Technology, 220 g/m², 89 % DuPont™ Nomex®, 9 % DuPont™ Kevlar®, 2 % P140 antistatic, with Repel+ finish

Moisture barrier/insulation:

GORE-TEX® PARALLON™ System

Color:

Gold/ Black Blue

Norms:

EN 469:2005 Level 2
EN 1149-5

Available sizes:

XS – 3XL
Short sizes: KXS – KXXL
Long sizes: LS – LXXL

NON-LETHAL

BOAT STOPPING SYSTEMS (BSS)

Safetystyle has many years of experience producing non-lethal Boat Stopping Systems (BSS). These three variations each use a pneumatic launcher that fires an arrestor line across the bow of a suspect or intruding vessel.

This provides a **non lethal, quick, easy and reliable** means of stopping vessels. The BSS are **unique, patented** maritime defence systems which are non lethal, **100% effective**, simple to use and **extensively tested**.

THE LINE ARRESTOR SYSTEM:



The arrestor line system is simple and effective

Each system fires a floating Dynema or Spectra line with a sea anchor at both ends.

The line and sea anchors are launched, and the sea anchors deploy.

The floating line catches on the rudder or the propeller shaft. The sea anchors inflate and create many tons of drag to stop the target vessel.

- 1 The line and sea anchors are launched in a streamlined container (the munition)
- 2 The floating line captures the cavitation plate/anti-ventilation plate on outboard or inboard/outboard motors, or the boat's rudder etc.
- 3 The sea anchors deploy and inflate to create many tons of drag to slow the target vessel to a stop in seconds.
- 4 The line normally does not foul the propeller or damage the vessel.



CHOOSE FROM STRAIGHT LINE OR V-SHAPED LAUNCHER:

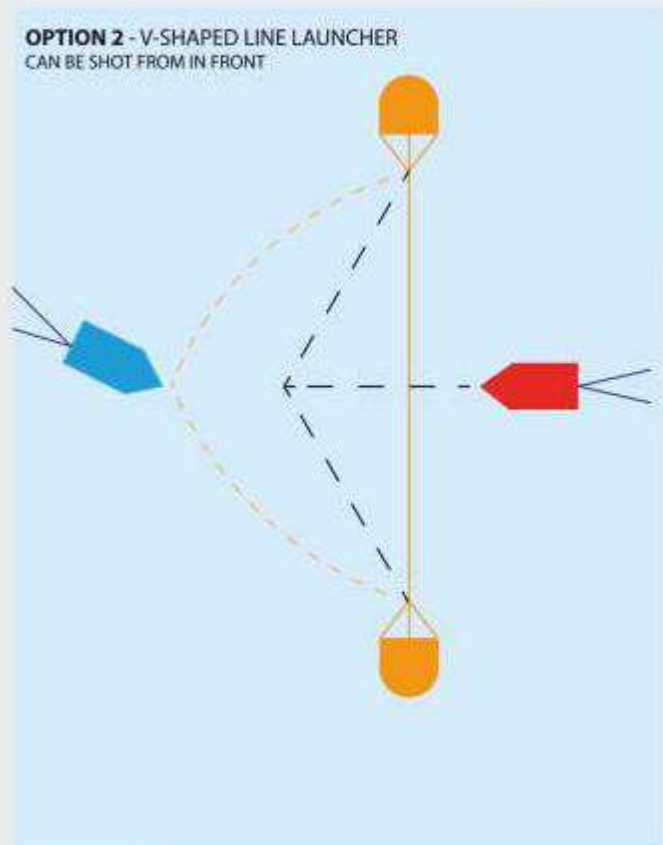
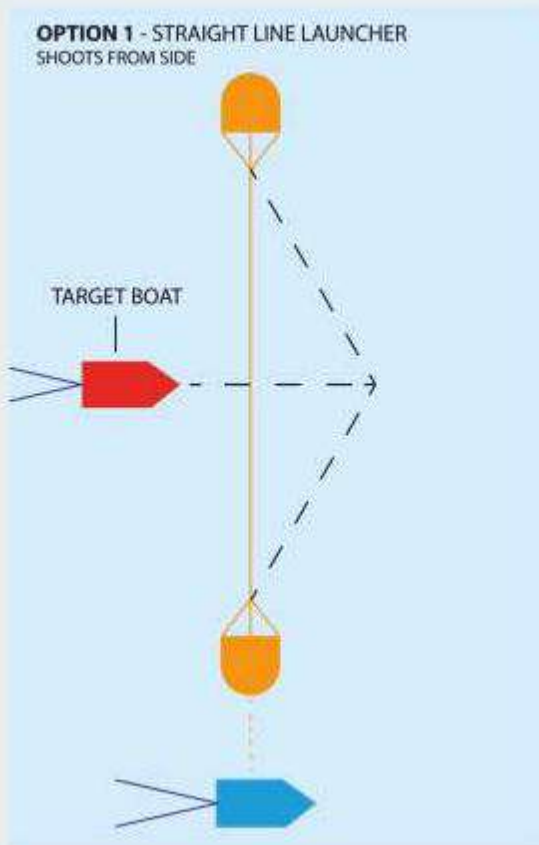

Both Buccaneer and Sea Stinger can be given **unique capability** by mounting two barrels on a common manifold in a V configuration so that the launcher can **fire both ends of the floating line at once**, thus enabling the line to be projected perpendicular to the firing point.

This is effective in a **head-on encounter scenario** where a line can be laid down in front of the target, for **protecting an asset against an incoming threat** or laying down a barrier behind the launching vessel.

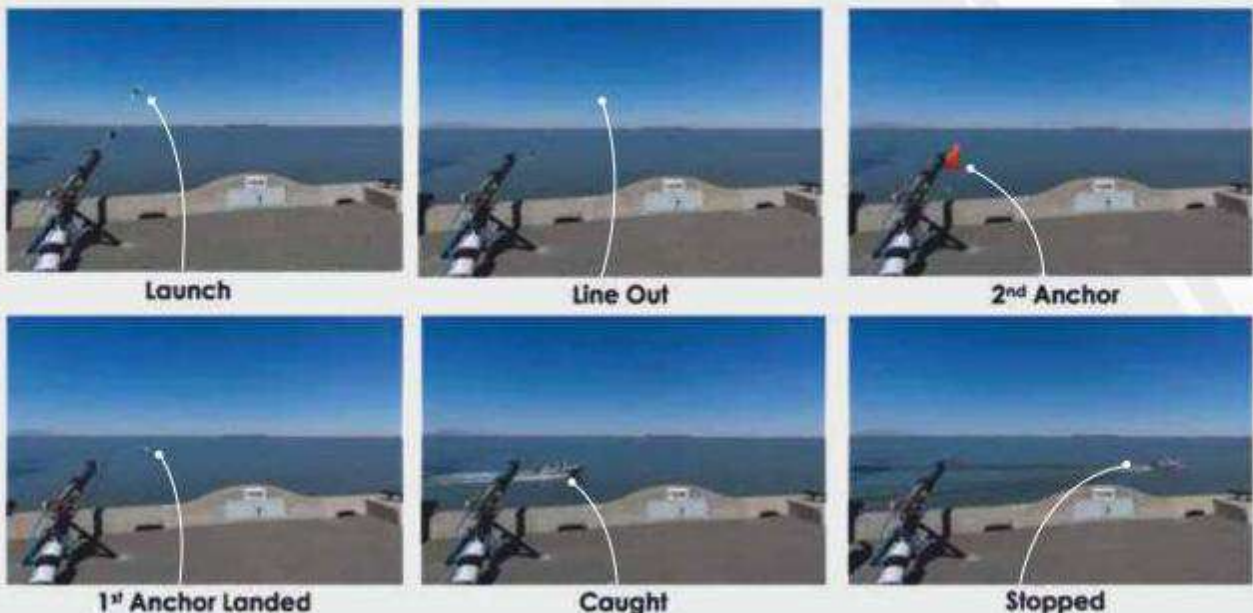

NON-LETHAL BOAT STOPPING SYSTEMS (BSS)

The BSS in action:



Three variants - Barracuda, Buccaneer and Sea Stinger:

FEATURE	BARRACUDA (HAND-HELD)	BUCCANEER (SHIP BORNE)	SEA STINGER (PORT OR LARGER VESSEL)
Barrel diameter	5" (125mm)	5" (125mm)	7" (175mm)
Maximum range (approx)	40yds (36m)	200yds (200m)	437yds, 400m (line) 328yds, 300m (net)
Typical line length	40yds (36m)	100yds (100m)	218yds, 200m (line) 100m (net)
Typical barrel length	24" (50cm)	48" (1.2m)	48" (1.2m)
Max operating charge	11bar (160psi)	40bar (600psi)	40bar (600psi)
Total weight	28.6lbs (13kg)	72lbs (33kg)	430lbs (195kg)
Dimensions	6" x 52" (15cm x 130cm)	47" x 11" (117cm x 27cm)	59" x 23" (147cm x 57cm)
Suggested application	For hand-held use on or off shore. Use in confined waterways.	This medium launcher can have a single or twin V shaped barrel fitted. For use on all sizes of vessels from RIBs to capital ships to merchant vessels. Can be used to fire a line for ship to ship or ship to shore.	For closing quickly a port, harbour or estuary or for non lethal protection of a navy, coastguard vessel or oil rig. To protect any maritime assets.

Comparitive diagram of the three BSS variants:

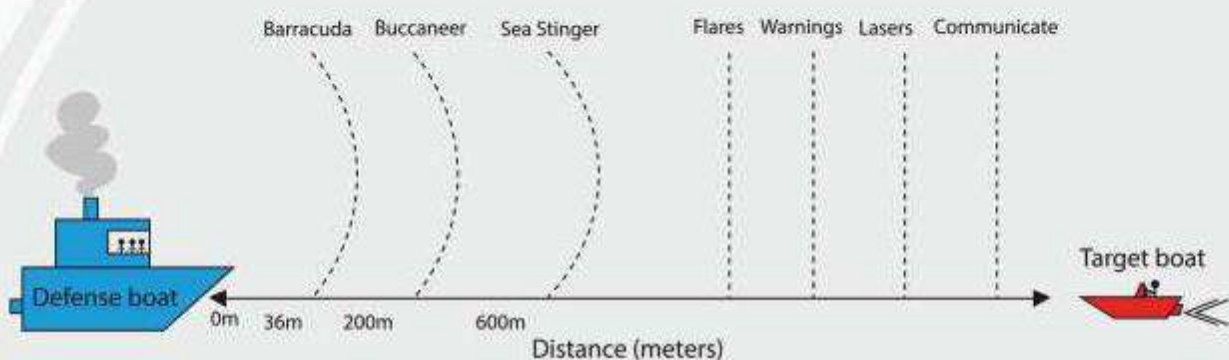



BARRACUDA

1

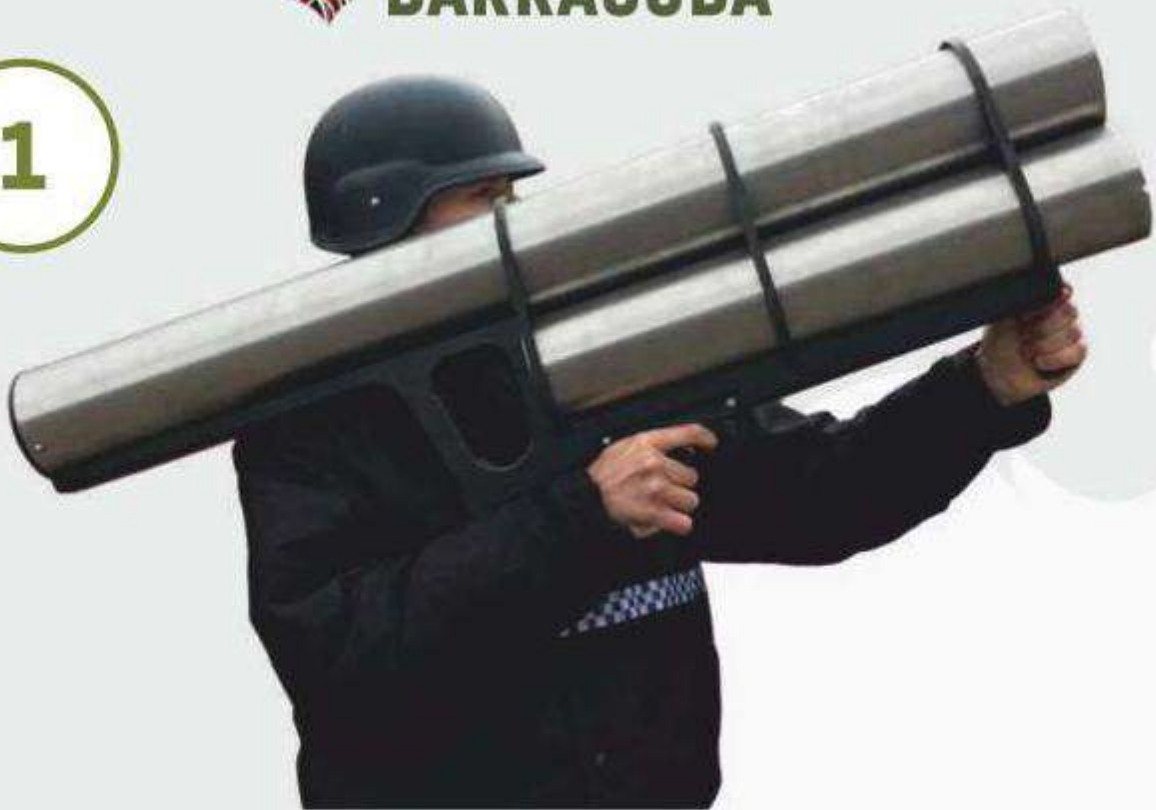

A hand-held device capable of launching a 36 metre (40 yard) arrestor line and two 3 ft (1m) sea anchors.

Operates at a low pressure of 150 pounds per square inch

Works in a variety of sea states



Ideal for close-in interception

Comes in carrying case with two munitions

Code	BARR001
	13kg (28.6lbs)
	15x130cm (6"x52")

NON-LETHAL

BOAT STOPPING SYSTEMS (BSS)

2

BUCCANEER

In recent trials the buccaneer stopped a 3 ton boat at 25 knots in seconds

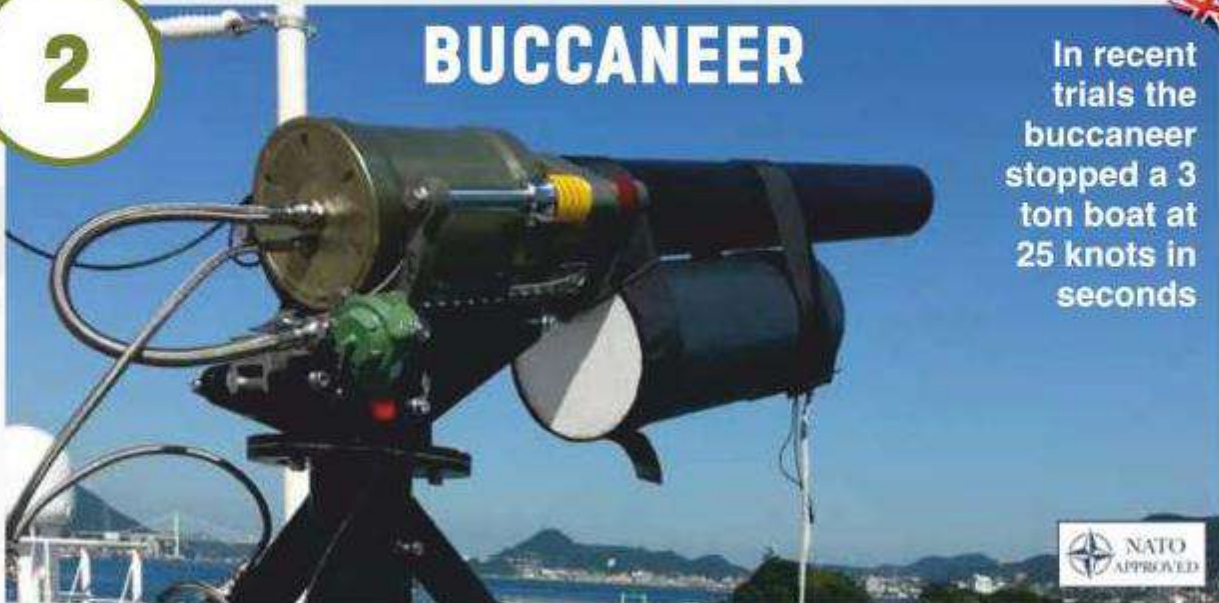

The Buccaneer KIS delivers projectiles designed to deter and disable small fast sea craft at extended range

With a range of up to 200 meters the Buccaneer KIS uses specialised payloads to lay **buoyant netting / line** for interdiction operations. The Buccaneer KIS is **extremely flexible** having a **360 degree rotation and depression and elevation of 45 degrees from horizontal**.

It can be operated remotely from the bridge or control room quickly and safely and uses **no explosive or pyrotechnics parts in its use**.

The Buccaneer can be loaded with alternative projectiles such as **high density smoke, flares, or buoyancy aids**.

Projectiles to either:

Lay **netting** over a wide area

Lay a **buoyant line** or lines

Or to **entangle the assaulting crafts propeller**.

Dispense **airburst smoke** or an **irritant gas**

Dispense **multiple small projectiles** over a wide area - up to a 50 meter square - in a **scatter gun** approach



Control station for remote firing



The projectiles:

Non lethal - like paintballs

Less than lethal - like squash balls

Lethal - like gravel or golf balls

This provides a layered defence.

The lethality can be increased if the approaching craft is not initially deterred.

Alternatively, it can deploy:

Survival items to a man overboard like a single seat liferaft or buoyancy aids

A rope line to shore for mooring, or to another vessel for **towing**

Code	BUC001
NATO	NSN:1095-99-993-1079
	33kg (72lbs)
	117cm x 27cm (47" x 11")

- **Non Lethal** - increasing the safety of building occupants
- **Extensively tested and engineered to the highest standards.**





- **Easy to operate and maintain**
- Adaptable and **flexible to your operational needs**
- Can be recharged and **loaded in seconds**
- **Low cost**
- In service now worldwide with **S.F., SWAT and Military units**



Fitted with a Recoil Mitigation System the WBS uses water or sand filled projectiles. Reduces collateral damage and increasing safety for building occupants: such as hostages or for search and rescue operations.



Code	WB05
NATO	NSN:1095-99-474-6909
	102.5kg (16 stone, 2lbs)
	66.5 (H) x 80 (W) x 101.5cm (D) (26 x 31.5 x 40")



